

# Installation Manual

## Veritas R8 Plus/Veritas Excel

INS045-13



**Texecom**

# Contents

- 1. Quick Reference and Factory Settings ..... 4**
  - Programming Guide .....4
  - Reference Table .....5
  - Miscellaneous Options .....6
- 2. System Overview ..... 7**
  - System Architecture .....7
  - Control Panels .....7
    - Veritas R8 Plus & Excel .....7
  - Remote Keypads .....7
    - Veritas R8 Remote Keypad .....7
    - Veritas Excel Remote Keypad .....7
- 3. Installation ..... 8**
  - Installation Sequence .....8
  - Control Panel .....8
    - Mounting the Control Panel .....8
  - Wiring the Control Panel .....8
  - Control Panel PCB Layout .....9
  - Connecting AC Mains ..... 10
  - Connecting Batteries ..... 10
  - Installing Remote Keypads ..... 10
  - Cable Distances ..... 10
  - Keypad Addressing ..... 10
    - Addressing for Excel Keypad ..... 10
    - Addressing for Standard R8 Keypad ..... 10
  - Configuring the Keypads ..... 10
  - Zone Connections ..... 11
    - Magnetic Contacts and Panic Buttons ..... 11
    - Powered Detectors ..... 12
  - End Of Line Technology ..... 13
  - Global System Tamper ..... 14
  - Speaker Connections ..... 14
  - Internal Siren(s) ..... 14
  - Wiring the External Sounder ..... 15
    - Popular SAB Wiring Diagrams ..... 15
  - Wiring a Communicator ..... 15
    - Wiring Example ..... 15
  - Connecting a Computer ..... 15
  - PC-Com ..... 16
  - Commissioning (Initial Power Up) ..... 16
  - Servicing the System ..... 16
  - Trouble Shooting ..... 17
    - No Power to the Unit (Mains Only) ..... 17
    - No Power to the Unit (Battery Only) ..... 17
    - No Power to the Unit (Mains & Battery) ..... 17
    - Unit Does Not Accept Code ..... 17
    - Unit Will Not Set and Bleeps 10 Times ..... 17
    - Unit Will Not Set and Bleeps 9 Times ..... 17
    - Remove ALL Temporary Links ..... 17
    - Unit Will Not Set and Bleeps 1 - 8 Times ..... 18

- Unit Goes Into False Alarm ..... 18
- Unit Makes No Sound ..... 18
- System Operates but Keypad Makes No Sound ..... 18
- External Sounder/Strobe Does Not Work ..... 18
- The Panic Button Does Not Work ..... 18
- Service Timers Cannot Be Programmed ..... 18

## 4. Programming the Control Panel ..... 19

- Introduction ..... 19
  - The Programming Menu ①① - ①⑧ ..... 19
  - Programming With an LCD Keypad ..... 19
- Available LCD Menus ..... 19
- The Miscellaneous Selections ①① - ①③ ..... 20
  - Miscellaneous Selections Zero ①① ..... 20
  - Miscellaneous Selections One ①① ..... 20
  - Miscellaneous Selections Two ①② ..... 21
  - Miscellaneous Selections Three ①③ ..... 22
- Number of Alarm Activations (Re-arms) ①④ ..... 22
- Testing the Sounders, Strobe ①⑤ ..... 23
- Walk Testing ①⑥ or ①⑨ ..... 23
- Re-Loading the Factory Settings ①⑦ ..... 23
- Programming the SW+ Output ①⑧ ..... 24
- Configuring Remote Keypads ①⑨ ..... 24
- Programming Zone Types ①① - ①⑧ ..... 25
  - Description of Zone Types ..... 25
  - Push To Set ..... 25
  - Inhibited Entry ..... 25
  - Guard ..... 25
  - Fire ..... 25
  - Tamper ..... 25
  - Entry/Exit ..... 25
  - Personal Attack ..... 25
  - Keyswitch ..... 25
  - 24 Hour Zone Types ..... 26
  - Programming the Zone Type ①① - ①⑧ ..... 26
- Changing Part Set Zone Types ②① - ②③ ..... 26
  - Programming Part Sets Zone Changes ②① ..... 27
  - Changing Zones to Entry/Exit ②① ..... 27
  - Changing Zones to Inhibited Entry ②② ..... 27
  - Changing Zones to Guard ②③ ..... 27
- Programming the Date and Time ②⑤ - ②⑥ ..... 27
  - Programming the Date ②⑤ ..... 27
  - Programming the Time ②⑥ ..... 28
- Programming the Service Timers ②⑦ - ②⑨ ..... 28
  - Programming Service Timer One ②⑦ ..... 28
  - Programming Service Timer Two ②⑧ ..... 28

Programming Service Timer Three ②⑨ ..... 28	
Programming System Timers ③① - ③⑨ ..... 29	
The Seven Event Basic Log ④① - ④⑦ ..... 29	
Clearing the Seven Event Basic Log ④① ..... 29	
Displaying the Seven Event Basic Log .....④① - ④⑦ ..... 29	
Programming the Suites ④⑧ - ⑤⑨ ..... 30	
Programming the Zone Disable Suite ④⑧ ..... 30	
Programming the Zone Soak Test Suite ④⑨ ..... 30	
Programming the Full Set Suite ⑤① ..... 30	
Programming the Part Set Suites ⑤① - ⑤④ ..... 30	
Programming the Chime Suite ⑤⑤ ..... 31	
Programming the Cleaner Suite ⑤⑥ ..... 31	
Programming the Double Knock Suite ⑤⑦ ..... 31	
Programming the Manual Omit Suite ⑤⑧ ..... 31	
Programming the Zone Invert Suite ⑤⑨ ..... 31	
Assigning Access Codes ⑥① - ⑦⑨ ..... 32	
User Number ..... 32	
Access Code ..... 32	
Access Level ..... 32	
Access Types ..... 33	
Changing Your Own Access Code ⑥① ..... 33	
Assigning New Access Codes ⑥① - ⑦⑧ ..... 33	
Programming Access Codes ⑥① - ⑥⑧ ..... 33	
Programming Access Levels .....⑦① - ⑦⑧ ..... 33	
Displaying User Information ⑥⑨ & ⑦⑨ ..... 34	
Displaying Your User Number ⑥⑨ ..... 34	
Displaying Your Access Level ⑦⑨ ..... 34	
The Communicator Interface ⑧① - ⑧① ..... 34	
Programming Communicator Selections ⑧① ..... 34	
Testing the Communicator Interface ⑧① ..... 35	
The 250 Event Extended Log ⑨① ④① ..... 35	
Viewing the Extended Log ⑨① ④① ..... 35	
Event Log Descriptions ..... 35	
Programming Text ⑨① ⑤① - ⑨① ⑨① ..... 36	
Programming Zone Text ⑨① ⑤① ..... 36	
Programming User Name Text ⑨① ⑥① ..... 36	
Banner Text ⑨① ⑦① ..... 36	
Broadcast Text ⑨① ⑧① ..... 36	
Default Text ⑨① ⑨① ..... 36	
<b>5. Specifications..... 37</b>	
Control Panel..... 37	
Power supply ..... 37	
Electrical..... 37	
Physical ..... 37	
Environmental ..... 37	
Keypads ..... 37	
Safety Notes..... 37	
Warranty ..... 37	
European Standards..... 37	
EN 50131 ..... 37	
<b>6. Installation Records..... 38</b>	
<b>Installation Details ..... 38</b>	
Maintenance & Call-Out Record ..... 38	
Access Code Table ..... 39	

# 1. Quick Reference and Factory Settings

## Programming Guide

Programming Option	Option Code	Programming Procedure	Factory Setting
Miscellaneous Selections Zero	0 0	Select/De-select Option Number(s) 1 to 8 Press <b>PROG.</b>	
Miscellaneous Selections One	0 1	Select/De-select Option Number(s) 1 to 8 Press <b>PROG.</b>	
Miscellaneous Selections Two	0 2	Select/De-select Option Number(s) 1 to 8 Press <b>PROG.</b>	
Miscellaneous Selections Three	0 3	Select/De-select Option Number(s) 1 to 8 Press <b>PROG.</b>	
Number of Alarm Activations	0 4	Enter Number of Alarm Activations ?? Press <b>PROG.</b>	03
Test Sounders, Strobe, SW+	0 5	Press 5 4 3 2 1 in Turn Press <b>RESET</b>	
Walk Test (Non-Latching)	0 6	Conduct Walk Test Press <b>RESET</b>	
Re-Load Factory Settings	0 7	Press <b>PROG.</b>	
Switched Positive Output	0 8	Select Function 1 to 8 Press <b>PROG.</b>	Set +Ve with Reset (6)
Configure Remote Keypads	0 9	View Display Press <b>PROG.</b>	
Zone 1 Zone Type	1 1	Select Zone Type 1 to 8 Press <b>PROG.</b>	Entry/Exit (6)
Zone 2 Zone Type	1 2	Select Zone Type 1 to 8 Press <b>PROG.</b>	Inhibited Entry (2)
Zone 3 Zone Type	1 3	Select Zone Type 1 to 8 Press <b>PROG.</b>	Guard (3)
Zone 4 Zone Type	1 4	Select Zone Type 1 to 8 Press <b>PROG.</b>	Guard (3)
Zone 5 Zone Type	1 5	Select Zone Type 1 to 8 Press <b>PROG.</b>	Guard (3)
Zone 6 Zone Type	1 6	Select Zone Type 1 to 8 Press <b>PROG.</b>	Guard (3)
Zone 7 Zone Type	1 7	Select Zone Type 1 to 8 Press <b>PROG.</b>	Guard (3)
Zone 8 Zone Type	1 8	Select Zone Type 1 to 8 Press <b>PROG.</b>	Guard (3)
Walk Test (Latching)	1 9	Conduct Walk Test Press <b>RESET</b>	
Part Sets Which Change Zone Types	2 0	Select Part Set(s) 1 to 4 Press <b>PROG.</b>	Parts Sets 1 & 3
Change into Entry/Exit Suite	2 1	Select Zone Number(s) 1 to 8 Press <b>PROG.</b>	Zone 2 Included
Change into Inhibited Entry Suite	2 2	Select Zone Number(s) 1 to 8 Press <b>PROG.</b>	No Zones Included
Change into Guard Suite	2 3	Select Zone Number(s) 1 to 8 Press <b>PROG.</b>	Zone 1 Included
Program Current Date	2 5	Enter Date DD/MM/YY Press <b>PROG.</b>	
Program Current Time	2 6	Enter Time HH:MM:SS Press <b>PROG.</b>	
Program Service Timer 1 Date	2 7	Enter Date DD/MM/YY Press <b>PROG.</b>	
Program Service Timer 2 Date	2 8	Enter Date DD/MM/YY Press <b>PROG.</b>	
Program Service Timer 3 Date	2 9	Enter Date DD/MM/YY Press <b>PROG.</b>	
EOL Resistor Values	3 0	Select/De-select Option Number(s) 1 or 2 Press <b>PROG.</b>	1
Full Set Exit Time (sec)	3 1	Enter Exit Time ?? Press <b>PROG.</b>	30 sec
Part Set Exit Time (sec)	3 2	Enter Exit Time ?? Press <b>PROG.</b>	30 sec
Full Set Entry Time (sec)	3 3	Enter Entry Time ?? Press <b>PROG.</b>	30 sec
Part Set Entry Time (sec)	3 4	Enter Entry Time ?? Press <b>PROG.</b>	30 sec
Bell Cut-Off Time (min)	3 5	Enter Cut-Off Time ?? Press <b>PROG.</b>	15 min
Error Tone Suspension Time (sec)	3 6	Enter Suspension Time ?? Press <b>PROG.</b>	10 sec
Bell Delay Time (min)	3 7	Enter Delay Time ?? Press <b>PROG.</b>	00 (Instant Bells)
Confirmation Time (min)	3 8	Enter Second Intruder Time ?? Press <b>PROG.</b>	45 min
Zone Soak Test Time (days)	3 9	Enter Soak Test Time ?? Press <b>PROG.</b>	14 days
Clear Seven Event Basic Log	4 0	Press <b>PROG.</b>	
Basic Log Event 1 (most recent)	4 1	View Display (Press <b>OMIT</b> for Extended Display) Press <b>RESET</b>	
Basic Log Event 2	4 2	View Display (Press <b>OMIT</b> for Extended Display) Press <b>RESET</b>	
Basic Log Event 3	4 3	View Display (Press <b>OMIT</b> for Extended Display) Press <b>RESET</b>	
Basic Log Event 4	4 4	View Display (Press <b>OMIT</b> for Extended Display) Press <b>RESET</b>	
Basic Log Event 5	4 5	View Display (Press <b>OMIT</b> for Extended Display) Press <b>RESET</b>	
Basic Log Event 6	4 6	View Display (Press <b>OMIT</b> for Extended Display) Press <b>RESET</b>	
Basic Log Event 7 (least recent)	4 7	View Display (Press <b>OMIT</b> for Extended Display) Press <b>RESET</b>	

Programming Option	Option Code	Programming Procedure	Factory Setting
Zone Disable Suite	④ ⑧	Select Zone Number(s) ① to ⑧ Press (PROG.)	No Zones Included
Zone Soak Test Suite	④ ⑨	Select Zone Number(s) ① to ⑧ Press (PROG.)	No Zones Included
Full Set Suite	⑤ ⑩	Select Zone Number(s) ① to ⑧ Press (PROG.)	All Zones Included
Part Set Suite 1	⑤ ①	Select Zone Number(s) ① to ⑧ Press (PROG.)	Zones 5, 6, 7 Omitted
Part Set Suite 2	⑤ ②	Select Zone Number(s) ① to ⑧ Press (PROG.)	Zones 5, 6, 7 Omitted
Part Set Suite 3	⑤ ③	Select Zone Number(s) ① to ⑧ Press (PROG.)	Zones 5, 6, 7 Omitted
Part Set Suite 4	⑤ ④	Select Zone Number(s) ① to ⑧ Press (PROG.)	Zones 5, 6, 7 Omitted
Chime Suite	⑤ ⑤	Select Zone Number(s) ① to ⑧ Press (PROG.)	No Zones Included
Cleaner Suite	⑤ ⑥	Select Zone Number(s) ① to ⑧ Press (PROG.)	No Zones Included
Double Knock Suite	⑤ ⑦	Select Zone Number(s) ① to ⑧ Press (PROG.)	No Zones Included
Manual Omit Suite	⑤ ⑧	Select Zone Number(s) ① to ⑧ Press (PROG.)	Zone 1 Omitted
Zone Invert Suite	⑤ ⑨	Select Zone Number(s) ① to ⑧ Press (PROG.)	No Zones Included
Program Your Own Code PIN	⑥ ⑩	Enter New Code PIN ? ? ? ? Press (PROG.)	
Program Code 1 PIN	⑥ ①	Enter New Code PIN ? ? ? ? Press (PROG.)	④ ③ ② ①
Program Code 2 PIN	⑥ ②	Enter New Code PIN ? ? ? ? Press (PROG.)	① ② ③ ④
Program Code 3 PIN	⑥ ③	Enter New Code PIN ? ? ? ? Press (PROG.)	
Program Code 4 PIN	⑥ ④	Enter New Code PIN ? ? ? ? Press (PROG.)	
Program Code 5 PIN	⑥ ⑤	Enter New Code PIN ? ? ? ? Press (PROG.)	
Program Code 6 PIN	⑥ ⑥	Enter New Code PIN ? ? ? ? Press (PROG.)	
Program Code 7 PIN	⑥ ⑦	Enter New Code PIN ? ? ? ? Press (PROG.)	
Program Code 8 PIN	⑥ ⑧	Enter New Code PIN ? ? ? ? Press (PROG.)	
Display Your Own User Number	⑥ ⑨	View Display Press (RESET)	
Display Panel Type	⑦ ⑩	View Display Press (RESET)	Z1, Z2, Z3 On
Program Code 1 Access Level	⑦ ①	Select Access Level ① to ⑧ Press (PROG.)	Master User (5)
Program Code 2 Access Level	⑦ ②	Select Access Level ① to ⑧ Press (PROG.)	Boss Engineer (8)
Program Code 3 Access Level	⑦ ③	Select Access Level ① to ⑧ Press (PROG.)	Null (7)
Program Code 4 Access Level	⑦ ④	Select Access Level ① to ⑧ Press (PROG.)	Null (7)
Program Code 5 Access Level	⑦ ⑤	Select Access Level ① to ⑧ Press (PROG.)	Null (7)
Program Code 6 Access Level	⑦ ⑥	Select Access Level ① to ⑧ Press (PROG.)	Null (7)
Program Code 7 Access Level	⑦ ⑦	Select Access Level ① to ⑧ Press (PROG.)	Null (7)
Program Code 8 Access Level	⑦ ⑧	Select Access Level ① to ⑧ Press (PROG.)	Null (7)
Display Your Own Access Level	⑦ ⑨	View Display Press (RESET)	
Communicator Interface Selections	⑧ ⑩	Select/De-select Option Number(s) ① to ⑧ Press (PROG.)	
Test Communicator Interface	⑧ ①	Toggle Channel(s) ① to ⑧ Press (RESET)	

**Reference Table**

Number	Test Outputs ⑩ ⑤	SW= Function ⑩ ⑧	Zone Types ① ②	Extended Display
0	All Off			
1	Bell	Set +Ve	Push To Set	Bell & Global Tamper
2	Strobe	Alarm +Ve & Reset	Inhibit Entry	Power
3	Sounder Lo	Reset	Guard	Lid Tamper (inc. RKP)
4	Sounder Hi	Tamper	Fire	Line Monitor
5	SW+	Mains Fail	Tamper	RKP Off-Line
6	Engineer Hold Off	Set +Ve & Reset	Entry/Exit	Code PIN Tamper
7		Walk Test	PA	Keypad PA
8		Entry/Exit	Keyswitch	EOL Tamper

**Miscellaneous Options**

Option	Miscellaneous Selections Zero ①①	Factory Setting
1	Cancel Strobe with Bell	Off
2	Keypad PA (pressing ③ and ⑨ together causes PA alarm)	Off
3	Single Button Setting	On
4	Silent Part Set Confirmation Tone	Off
5	EN 50131-1 Requirements	Off
6	Time Limit Engineer Access	Off
7	Reset Button Cancels Setting	On
8	Automatically Omit a Mains Fail Condition (Auto-Omit AC Off)	Off

Option	Miscellaneous Selections One ①①	Factory Setting
1	Internal Sounders Only on Unset Tamper Alarm	On
2	Internal Sounders Only on Part Set Zone Alarm	On
3	Internal Sounders Only on Part Set Tamper Alarm	On
4	Silent Part Set (no exit tone on part set)	Off
5	High Level Chime (chime at full volume)	Off
6	Invert Bell Output (negative removed instead of negative applied, useful for SCBs)	Off
7	Final Door Set (system sets 3 seconds after final door closure)	Off
8	Unlock Engineer Code (re-loading factory settings restores default Engineer code)	On

Option	Miscellaneous Selections Two ①②	Factory Setting
1	Engineer Reset on Any Alarm (see page 21)	Off
2	Engineer Reset on Tamper Alarm (see page 21)	Off
3	Disable User Ability to Omit Tamper	Off
4	Code PIN Tamper (tamper alarm after 16 invalid key presses when unset)	Off
5	Random Number Remote Reset (RNRR, see page 21)	Off
6	Push To Set (see page 22)	Off
7	Strobe Flash on Full Set (see page 21)	On
8	Invert Switched Positive Output (off = negative removed, on = negative applied)	Off

Option	Miscellaneous Selections Three ①③	Factory Setting
1	Mains Frequency (off = 50Hz, on = 60Hz)	Off
2	EOL Tamper Alarm on Zone Short Circuit (S/C)	Off
3	EOL Tamper Alarm on Zone Open Circuit (O/C)	Off
4	Enable DD 243:2002 Options (see page 22)	Off
5	Enable Confirmation Signal After Entry Time Out	Off
6	Operation of a Keyswitch Zone is Momentary (Momentary KEYSW)	Off
7	Automatically Omit Zone on Alarm	Off
8	Automatically Omit Keyswitch Zone when EOL Tampered	Off

Option	Communicator Selections ⑧①	Factory Setting
1	Communicator Outputs Latch until System is Reset	On
2	Line Monitor Input causes Tamper Alarm on Line Cut	Off
3	Invert Communicator Outputs (off = active low, on = active high)	Off
4	Invert Remote Reset Input (off = active if negative removed, on = active if negative applied)	Off
5	Remote Reset Input Silences Internal Sounder during Alarm	Off
6	Remote Reset Input Clears Engineer Reset (see page 21)	Off
7	Silent PA	Off
8	Enable 90 Second Abort Time Limit	On

# 2. System Overview

## System Architecture

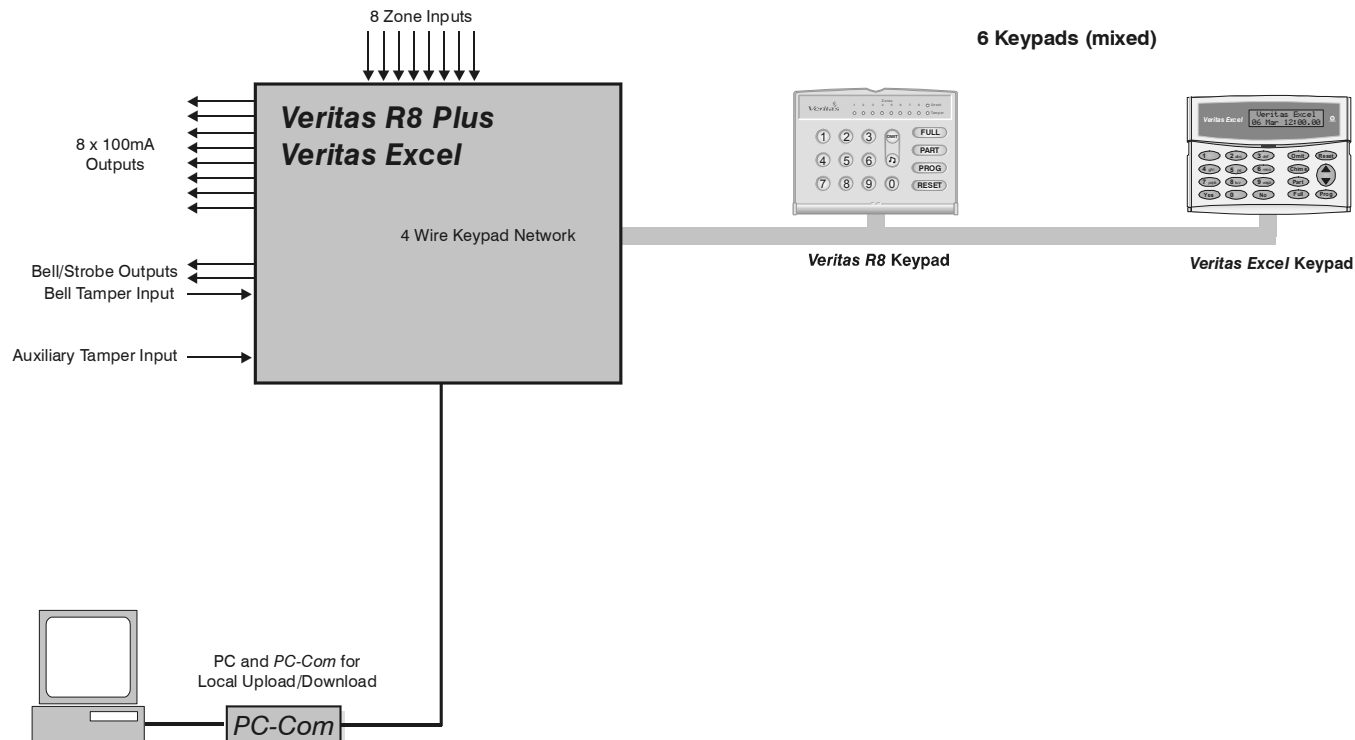

### Control Panels

#### Veritas R8 Plus & Excel

- 8 fully programmable Single Pole with Global Tamper or End Of Line zones
- 8 User Codes
- LED and/or LCD keypads
- Up to 6 keypads
- Engineer keypad facility
- 4-wire data network (standard 7/0.2 alarm cable)
- 4 Part Suites plus Full Set
- 8 communicator outputs
- 10 character zone text
- 16 character Banner Message
- 8 character User Name text

### Remote Keypads

#### Veritas R8 Remote Keypad

- LED keypad (8 zone indicators, tamper, power and unset)
- Solid keypad buttons
- Keypad cover
- Keypad PA (3 & 9)
- 4-wire connection to remote keypad network
- Built in Piezo sounder

#### Veritas Excel Remote Keypad

- 32 Character LCD keypad (power and unset indicators)
- Tactile sealed rubber keypad
- Keypad cover
- Keypad PA (3 & 9)
- 4-wire connection to remote keypad network
- Built in Piezo sounder
- 4 Part Suites plus Full Set

## 3. Installation

### Installation Sequence

Before attempting to install the alarm system, read this section. Once you have an overall understanding of the installation sequence, carefully work through each step.

#### 1. Design the Layout

Make a rough sketch of the premises to get an idea of where the alarm detection devices, keypads etc. are to be located.

#### 2. Mounting the Panel

The control panel should be mounted in a dry area close to an unswitched AC power source.



**NOTE** You must complete all wiring before connecting the battery or applying AC mains to the control panel.

#### 3. Installing the Keypads

Mount and connect the keypads to the control panel (see page 10 for wiring details).

#### 4. Installing the Alarm Detection Devices

Install the detection devices, PIR's, Contacts, PA Buttons etc. and connect them to the control panel (see page 11).

#### 5. Install the External Sounder

Install the external sounder and connect to the control panel (see page 15).

#### 6. Other Wiring

Complete all other wiring including speakers and output connections etc. (see pages 14 - 15 for wiring details).

#### 7. Applying Power to the Control Panel

Once steps 1 to 6 are completed, power can be applied to the control panel.



**NOTE** If you need to load the factory default settings (see page 16).

Power should always be connected in the following order:

- Connect the red battery lead to the positive terminal of the battery and then connect the black battery lead to the negative terminal.
- Connect the AC mains.

#### 8. Programming the Control Panel

Please refer to section 4 for instruction on programming the control panel.

#### 9. Testing the System

Test the system thoroughly to ensure that all features and functions operate as required (see page 23).

### Control Panel

#### Mounting the Control Panel

Mount the control panel on a flat, plumb wall using at least three appropriate screws. The rear casing has been designed with a central key-hole slot so that mounting is possible without removing the Printed Circuit Board (PCB). The angled slot in the lower corner has been provided to allow the panel to be levelled easily. If the PCB has to be removed, carefully pull back the two front PCB securing clips, lift the front of the PCB and slide it downward. To replace the PCB simply reverse the above procedure.



**NOTE** It is essential to ensure that none of the fixing slots or cable entries are accessible after fixing.

Mains cabling must be secured (e.g. with a cable tie) to one of the anchor points provided.

### Wiring the Control Panel

**WARNING: ELECTRICITY CAN KILL BEFORE connecting the control panel ALWAYS disconnect the supply at the consumer unit. If in ANY doubt consult a qualified electrician.**



**NOTE** ONLY connect the mains supply to the mains terminal block, NEVER connect the mains supply directly to the PCB.

ALWAYS refer to National Wiring Regulations when conducting installation.

An appropriate and readily accessible disconnection device (e.g. an unswitched fused spur) MUST be provided as part of the installation.

The disconnection device must NOT be fitted in a flexible cord.

Where identification of the neutral in the mains supply is NOT possible a two-pole disconnection device MUST be used.

The building mains supply MUST incorporate appropriate short-circuit backup protection (e.g. a fuse or circuit breaker) of High Breaking Capacity (HBC, at least 1500A).

Use mains cable of adequate carrying capacity for the rated current (i.e. at least 0.75mm<sup>2</sup>).



**Control Panel PCB Layout**

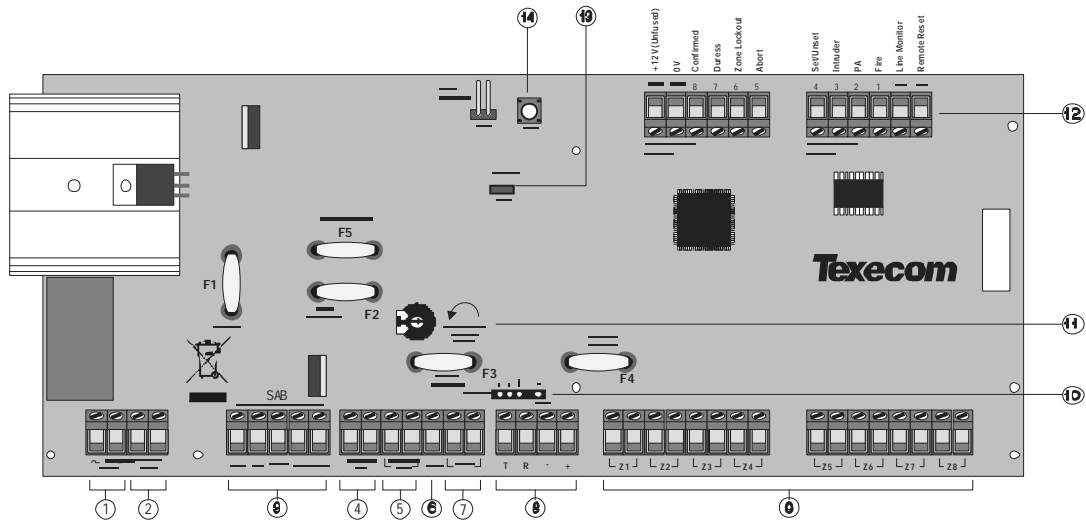

**1: AC Input**

Connected to the 16.5V transformer.

**!** DO NOT CONNECT THE MAINS SUPPLY TO THE AC INPUT TERMINALS ON THE PCB.

**2: Battery Connections**

A 12V rechargeable battery must be connected to these terminals in order to provide continuous system operation in the event of an AC Mains failure (see page 10).

**3: External Sounder Connections**

These terminals are used for connecting to an external sounder unit (see page 11 for wiring details).

**4: Loudspeaker Connections**

These terminals can be used for connecting up to one 16Ω or two 8Ω loudspeakers (see page 14).

**5: Auxiliary 12V Connections**

These terminals are for connecting devices that require 12V power (protected by a 1A fuse F1).

**6: SW+ Connections**

These terminals are for connecting devices that require 12V power (protected by a 1A fuse F1).

**7: Auxiliary Tamper Connections**

These terminals can be used for monitoring the box tamper of auxiliary devices such as power supplies etc. (see page 14).

**8: Keypad Network Connections**

These terminals provide connection for the keypads. The '+' and '-' terminals provide power whilst the 'T' transmits data and 'R' receives data (see page 10).

**9: Programmable Zones 1 - 8**

These terminals provide the connections for the 8 zones (see page 11). Each zone is also fully programmable (see page 25).

**10: Com1**

A portable Engineers keypad or a computer (using a PC-Com) can be plugged on here to make programming and testing the system easier.

**NOTE** When using a keypad as an Engineers keypad, the keypad's address must all be set to 6 (see page 10).

**11: Low Volume Control**

This variable resistor controls the volume level of advisory (entry/exit) tones (turn anticlockwise to increase volume).

**12: Communicator Interface**

These terminals provide UNFUSED 12V power; a remote reset input, a line fault input and 8 low current (100mA '-ve' applied) outputs and would normally be used when connecting a stand-alone communicator to the control panel (see page 15).

**13: Power Indicator**

This LED will be ON when AC mains is present on the control panel and will flash when there is no AC mains present on the control panel.

**14: Box Tamper Switch**

This switch provides tamper protection for the main control panel in case of unauthorised access. To disable the box tamper, fit a jumper link across the box tamper pins (if fitted).

**F1 - F5: Protection Fuses**

The following fuses are provided:

Fuse	Description	Rating
F1	Battery	1 Amp
F2	Bell and Strobe	1 Amp
F3	Auxiliary 12V and Speaker	500mA
F4	Keypad Network	500mA
F5	Power Supply	1.6 Amp

**Connecting AC Mains**

The AC Mains supply is connected to a 3 way 'Euro Type' fused terminal block, which is fitted with a fuse (see page 37).

**NOTE** All other wiring **MUST** be carried out before AC mains is connected to the control panel.

After connecting the AC Mains, fit the mains cover, this can be found in the spares bag.

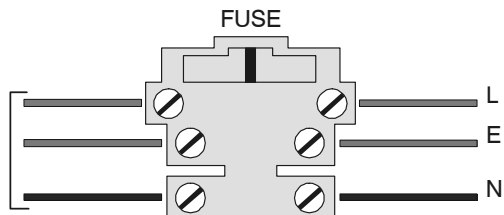

**Connecting Batteries**

Up to one 12V 7Ah battery can be fitted inside the control panel to provide continued operation in the event of an AC mains failure.

**NOTE** All other wiring **MUST** be carried out before the battery is connected to the control panel.

Connect the red battery lead to the positive terminal of the battery and connect the black battery lead to the negative terminal of the battery.

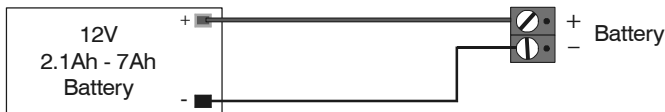

**Installing Remote Keypads**

A maximum of 6 remote keypads can be connected to the keypad network. The Veritas R8 Plus and the Veritas Excel supports both LED and LCD keypads.

The networks are made up of four terminals incorporating power and data. To ensure correct operation, all four terminals on the device must be connected to the corresponding terminals on the control panel, or previous keypad. The table below shows each terminal and its description:

Terminal	Description
+	+12V Supply
-	0V Supply
T	Transmit Data
R	Receive Data

Devices can be connected using 4-core cable. However, it is recommended that 6 or 8-core cable is used as the spare cores can be used to 'Double Up' on the power connections if needed.

**NOTE** Standard 7/0.2 alarm cable can be used for most installations. However, under certain conditions it may be necessary to use screened cable.

**Cable Distances**

The maximum recommended distance for devices when using standard 7/0.2 alarm cable is:

- 100m for each branch when using the star (parallel) configuration
- When using a daisy chain (series) configuration the maximum distance will depend on the number of devices connected on the chain. The more devices that are connected, the shorter the distance to the last device (this is due to voltage drop in the cable)

Whichever method of wiring configuration is used, ensure that the voltage between the '+' and '-' terminals at each device is no lower than 10.0V when the system is running on the standby battery.

**Keypad Addressing**

Each keypad **MUST** be given a different address using the DIP switch on the PCB as follows:

**Addressing for Excel Keypad**

Address	DIP 1	DIP 2	DIP 3	DIP 4
1	N/A	Off	Off	Off
2	N/A	Off	Off	On
3	N/A	Off	On	Off
4	N/A	Off	On	On
5	N/A	On	Off	Off
6	N/A	On	Off	On

**Addressing for Standard R8 Keypad**

Address	DIP 1	DIP 2	DIP 3	DIP 4
1	N/A	Off	Off	Off
2	Off	On	Off	On
3	Off	Off	On	Off
4	Off	Off	Off	On
5	On	Off	Off	On
6	Off	On	Off	On

**NOTE** NEVER set two RKPs to the same address.

Keypads are factory set to Address 1.

If the keypad is powered but offline (i.e. T and R not connected) it will display its address.

If an invalid address is selected, the keypad will sound an error tone.

**Configuring the Keypads**

Configuring keypads is described on page 24

**Zone Connections**

Detection devices such as PIR's, Door Contacts, PA Buttons etc. are all connected to the 8 zone terminals on the *Veritas R8 Plus* and *Veritas Excel* control panel.



**NOTE** If a zone is not being used it should be either linked out or disabled (see page 30).

**Magnetic Contacts and Panic Buttons**

These are connected to one of the eight terminal pairs labelled Z1 to Z8 on the control panel.

**Figure 1 - Wiring Magnetic Contacts**

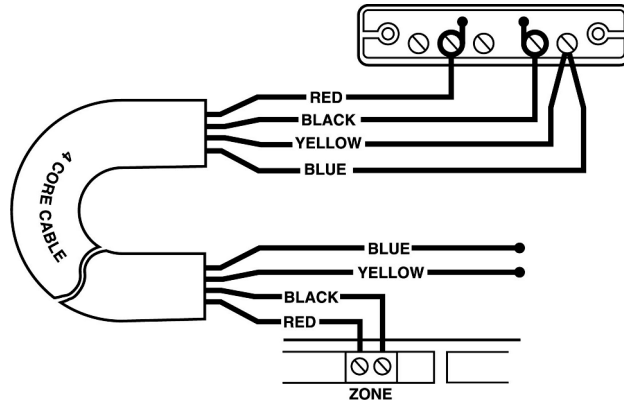

Figure 1a - Wiring a Single Magnetic Contact to a Zone (see also Figure 4).

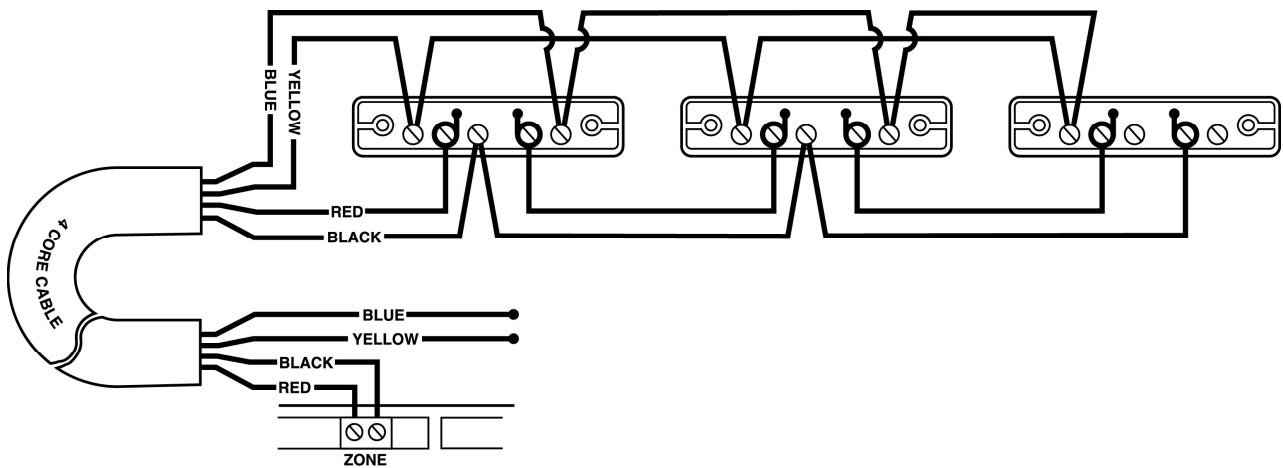

Figure 1b - Wiring Multiple Magnetic Contacts to a Zone (see also Figure 4).



**NOTE** Mixing powered detectors and magnetic contacts on one zone is easiest if the wiring is taken from the control panel to the powered detectors first.

**Powered Detectors**

Always consult the manufacturer's connection instructions. Powered detectors are connected to one of the eight terminal pairs labelled Z1 to Z8 on the control panel and are powered from the two terminals labelled AUX on the control panel as follows:

Terminal	Connect To	Suggested Colour
AUX+	Detector Positive Supply (+12V)	White
AUX-	Detector Negative Supply (0V)	Green

**Figure 2 - Wiring Powered Detectors**

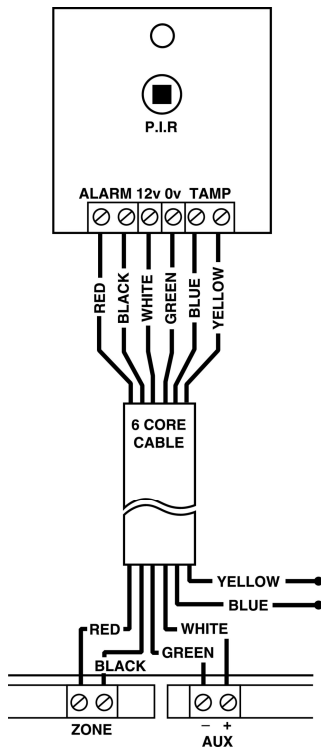

Figure 2a - Wiring a Single Powered Detector to a Zone (see also Figure 4).

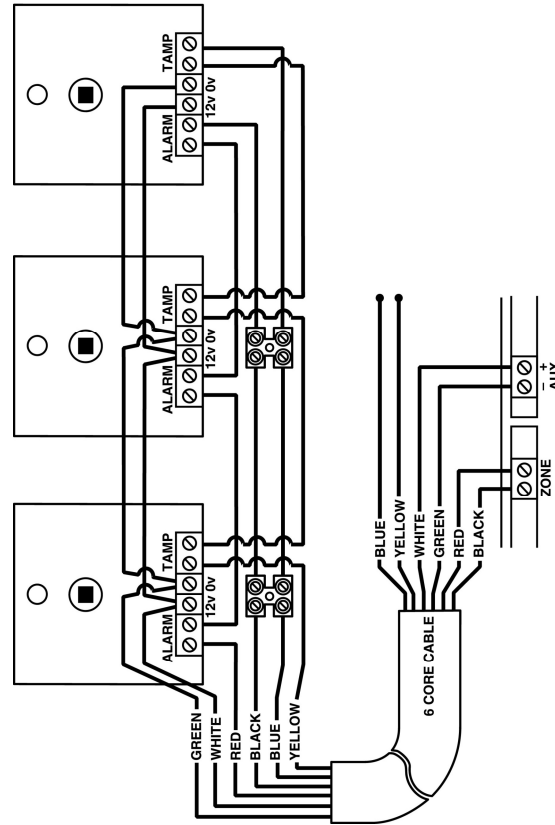

Figure 2b - Wiring Multiple Powered Detectors to a Zone (see also Figure 4).



Power is wired in parallel, whereas normally closed alarm loops are wired in series, (normally open alarm loops are wired in parallel).

Mixing powered detectors and magnetic contacts on one zone is easiest if the wiring is taken from the control panel to the powered detectors first.

BS 4737 requires that if two or more powered detectors are connected to one zone, they must each have an audible or visual latching indication or both, except on an entry/exit route.

**End Of Line Technology**

Those already familiar with End of Line (EOL) Technology (sometimes referred to as Balanced Zones) may wish to skip this section.

End of Line Resistance is a technique which, by adding resistance at the last detector in the loop, provides each loop with its own 24 hour tamper protection.

The panel can use two different types of EOL resistors, traditional Texecom 4K7/2K2, or Veritas values 10K/22K/33K. See page 28 for programming details.

**10K/22K/33K**

The panel can distinguish up to four possible states; low resistance (10kΩ) is interpreted as zone clear, high resistance (33kΩ) is interpreted as zone in fault. Short circuit may optionally be interpreted as tampering or zone clear. Open circuit may optionally be interpreted as tampering or zone in fault.

Resistors are coded with coloured bands to identify the different values, as follows:

Resistor Colour Code	
10kΩ	Brown, Black, Orange, Brown
22kΩ	Red, Red, Orange, Brown
33kΩ	Orange, Orange, Orange, Brown

Thus there are four possible configurations depending on the options selected. These include normally closed operation (a Global System Tamper zone is provided) and become progressively more secure, as follows:

**NOTE** The control panel is supplied with links fitted across the eight zones (Z1 - Z8), the Global System Tamper (TAMP) and Bell Tamper (SAB C, D) to simulate closed circuits.

These links are removed during installation as each zone is connected.

The Global System Tamper zone will typically only be used with normally closed operation.

If a zone is not required then the link should be left in place.

If EOL operation is selected and a zone is not required then the zone link should be replaced with a 10K resistor (supplied).

**NOTE** When wiring a 24 Hour zone (Fire, PA and Tamper), such as a panic button, it may be more convenient to fit the EOL resistor(s) in the panel than in the detector.

**Figure 3 - EOL Wiring**

Miscellaneous Option 3.2 (S/C = Tamper)	Off
Miscellaneous Option 3.3 (O/C = Tamper)	Off

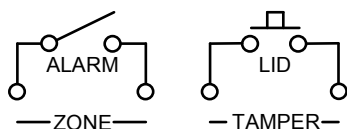

**Figure 3a - Normally Closed Operation.**

Miscellaneous Option 3.2 (S/C = Tamper)	On
Miscellaneous Option 3.3 (O/C = Tamper)	Off

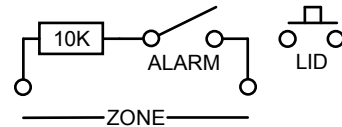

**Figure 3b - "American" Operation.**

Miscellaneous Option 3.2 (S/C = Tamper)	Off
Miscellaneous Option 3.3 (O/C = Tamper)	On

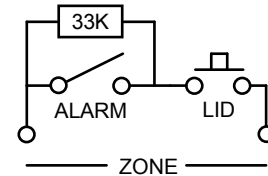

**Figure 3c - "European" Operation (one detector per zone).**

Miscellaneous Option 3.2 (S/C = Tamper)	On
Miscellaneous Option 3.3 (O/C = Tamper)	On

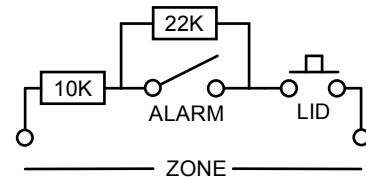

**Figure 3d - High Security Operation (one detector per zone).**

**4K7/2k2**

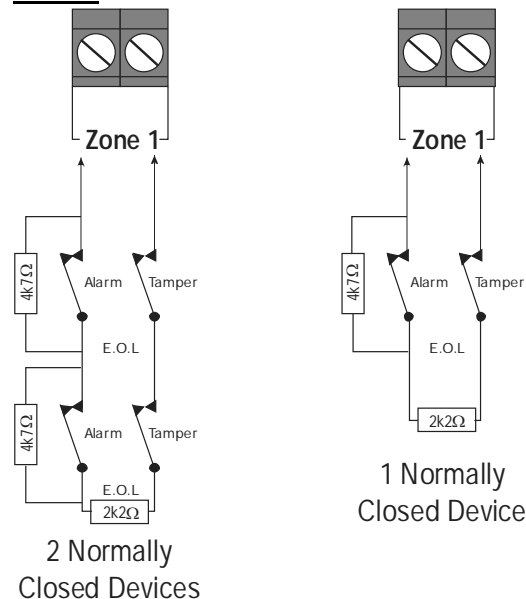

**Global System Tamper**

This is connected to the terminal pair labelled TAMP on the control panel. All the individual zone tamper loops should be wired in series.

**Figure 4 - Wiring the Global System Tamper**

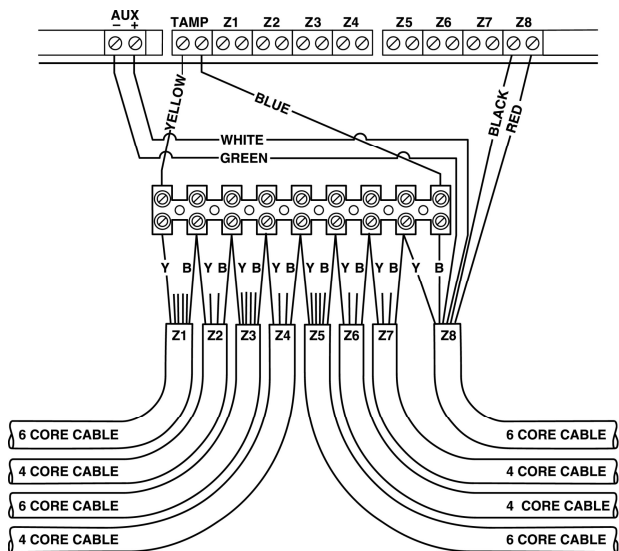

**NOTE** The control panel is supplied with a link fitted across the Global System Tamper to simulate a closed circuit. This link would usually be removed during installation. However the Global System Tamper will typically only be used with normally closed operation, with EOL operation the tamper link would usually be left in place.

**Speaker Connections**

This output can be used for driving up to one 16Ω or two 8Ω loudspeakers as shown below:

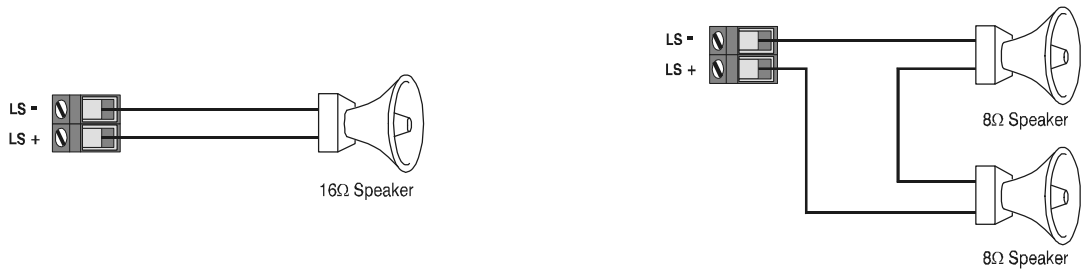

**NOTE** The total load including the built-in speaker must not be less than 16Ω (e.g. 1 x 16Ω speaker, 2 x 8Ω speakers in series, etc.). The polarity of extension speakers is usually unimportant, however, the polarity of the L/S terminals is indicated by a + and -.

**Internal Siren(s)**

If required these are connected to two of the external sounder connections, in addition to the external sounder, as follows:

Terminal	Connect To
A	Siren Positive Supply (+12V)
B	Siren Negative Activate/Negative Supply (0V)

**Wiring the External Sounder**

Always consult the manufacturer's connection instructions. The external sounder and strobe are connected to the five terminals labelled SAB on the control panel as follows:

Terminal	Description
A	Permanent Positive Supply (+12V)
B	Switched Negative to Activate Sounder
C	Negative Tamper Return
D	Permanent Negative Supply (0V)
S	Switched Negative to Activate Strobe

**Figure 5 - Typical SAB Connections**

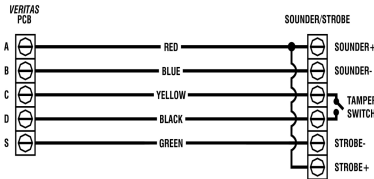

An external sounder is often referred to as a 'bell' or 'bell-box' even when it is actually an electronic siren.

The control panel is supplied with a link fitted across the Bell Tamper to simulate a closed circuit. This link would usually be removed during installation.

If the strobe is a separate unit take the strobe positive supply from 'A' as well.

A self-activating bell/sounder (SAB) has a built-in battery. After connecting this battery the sounder will usually sound until its cover is fitted and it is supplied with power from the control panel.

Terminal B may be programmed as switched negative removed rather than switched negative applied to activate sounder (see page 21). This is useful for SCBs where B would then be used to provide the permanent negative supply.

**Popular SAB Wiring Diagrams**

The following diagrams illustrate how to connect the control panel to the most popular makes of SAB:

**Texecom Odyssey.**

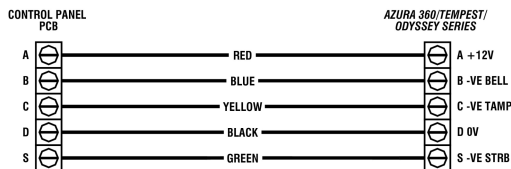

**Figure 6d - Volumatic Flashguard.**

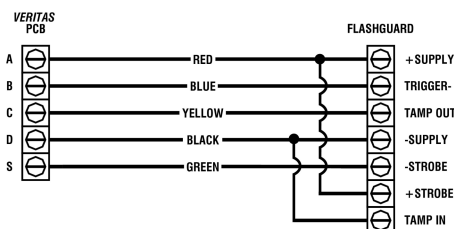

**Wiring a Communicator**

The control panel has eight outputs, which can be used for connecting to a stand-alone communicator. The table below shows the characteristics for each output:

Terminal	Type	Current	Operation
1	Fire	10mA	Switched 0V
2	PA	10mA	Switched 0V
3	Intruder	10mA	Switched 0V
4	Set/Unset	10mA	Switched 0V
5	Abort	10mA	Switched 0V
6	Zone Lockout	10mA	Switched 0V
7	Duress	10mA	Switched 0V
8	Confirmed	10mA	Switched 0V
L/M	Line Monitor	N/A	0V removed = Fault
R/R	Remote Reset	N/A	0V applied to reset



The operation of ALL outputs can be inverted if required (see page 34).

It is NOT possible to invert the individually outputs.

Following an alarm, the Zone Lockout output will activate at the end of the 2<sup>nd</sup> Intruder time if any zone remains open.

Do not use non-latching communicator outputs if selecting Automatic Omit (see page 22).

The operation of the R/R input may be inverted from 0V to reset to 12V to reset if required (see page 34).

The L/M input should be connected to 0V (AUX-) if not required, otherwise Bell Delay will not operate.

**Wiring Example**

The diagram below shows a typical wiring example:

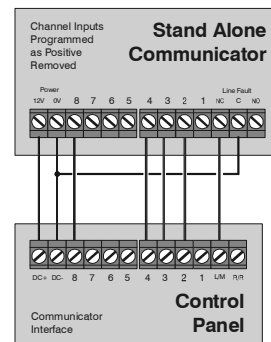

For details on testing the communicator outputs, see page 35.

**Connecting a Computer**

The Veritas R8 Plus and Veritas Excel both support local uploading and downloading between the control panel and a PC running Veritas UDL software. Uploading and Downloading can be used to program and interrogate the control panel.

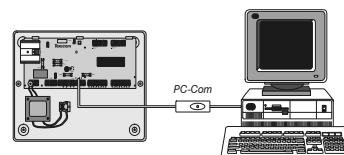

**PC-Com**

In order to connect a computer to the control panel, a *PC-Com* lead is required.

The *PC-Com* has a plug at either end of the cable. The 9-way D-type connector is for connection to a serial port on a computer and the 5-way Molex connector is plugged onto Com 1 on the control panel.

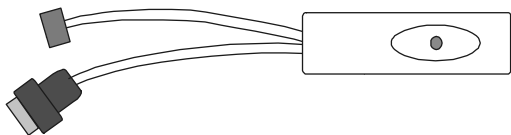

**Commissioning (Initial Power Up)**

**ALWAYS Ensure the mains is off BEFORE removing the front cover**

- Connect the black battery lead to the negative (-) terminal of the standby battery and the red battery lead to the positive (+) terminal of the standby battery. All the indicator lights will come on. After 10 seconds the zone lights will turn off and a repeating 9 beep error tone will start.

**To Load Factory Settings**  
 Apply power to the control panel and press **(RESET)** OR press and release the lid tamper spring 3 times BEFORE the zone lights turn off and the repeating 9 beep error tone starts

- Enter the factory set User code ④③②①. The error tone will stop.
- Enter the factory set Engineer code ①②③④ and press **(PROG.)** to access the Programming Menu and disable 24 Hour zones (Fire, PA and Tamper) via the Engineer code. All the zone lights will illuminate.
- Perform a Walk Test as described in on page 23. Remember that some powered detectors (e.g. PIRs and Combined Technology Detectors) take several minutes to warm up and become operational.
- Test the internal sounder, external sounder and strobe as described on page 23. To adjust the low-level volume use the control 'pot' on the PCB (see page 9), volume increases anti-clockwise. If the system fails to operate as expected check that the mounting and wiring are as per the instructions.
- Correct any mistakes and repeat the test (see page 17, Trouble Shooting).
- Replace the lid and secure with the two lid screws supplied - **do not over-tighten.**
- Fit the screw covers, these can be found in the spares bag.

- Press **(RESET)** to leave the Programming Menu. All the zone lights will turn off.
- The Power light will be flashing to indicate that action is required. Switch on the mains supply to the control panel. The Power light will stop flashing and stay on continuously. If the factory settings (see page 4) are not appropriate then re-program the system as described on see page 19.
- If you have a meter:
  - Disconnect the battery & check the total non-alarm current is less than 1A.
  - Reconnect the battery & check the total alarm current is not more than 1A.
- The total current is measured as follows:
  - Set your meter to DC current.
  - Connect your meter across F5 (power supply fuse).
  - Remove F5.
  - Record the current drain.
  - Replace F5.
  - Remove your meter.

**NOTE** To avoid accidentally powering down the system be sure to follow **all** the above steps **in order.**

**Installation is now complete and the system is ready for use.**

**NOTE** If the battery is flat or faulty the RKP may not accept key presses.

When the system is full set, after the exit period, the external strobe will flash for approximately 6 seconds (this option can be de-selected, see page 21).

**Servicing the System**

**ALWAYS Ensure the mains is off BEFORE removing the front cover**

**!** The Power light on the control panel is a status indicator for the battery charging circuit, a steady light meaning normal. A flashing light means action required - **mains power can still be present.** ALWAYS use a suitable mains test instrument to confirm that mains power is no longer present.

The transformer and heatsink may be hot during and after use - do NOT touch.

- Test the internal sounder, external sounder and strobe as described on page 23. Perform a Walk Test as described on page 23. Basic Log events may be viewed by following the procedure described on page 29.
- If it is necessary to remove the lid, first switch off the mains supply to the control panel. Ensure that the Power light is flashing, then use a suitable mains test instrument to confirm mains power is no longer present.
- Enter the 4 digit Engineer code **????** and press **(PROG.)** to access the Programming Menu and disable



24 Hour zones via the Engineer code. All the zone lights will illuminate.

- Remove the screw covers by inserting a screwdriver into the screw cover slot and turning anti-clockwise whilst applying pressure outwards.
- Unscrew the lid screws and remove the lid.
- On completion replace the lid and secure with the lid screws - **do not over-tighten**.
- Replace the screw covers.
- **Press** **RESET** to leave the Programming Menu. All the zone lights will turn off.
- Switch on the mains supply to the control panel. The Power light will stop flashing and stay on continuously.

### Trouble Shooting

#### **ALWAYS Ensure the mains is off BEFORE removing the front cover**



When replacing a fuse always observe the specified rating and type - failure to do so is dangerous and will invalidate the warranty. Fuses should comply with IEC 127.

#### **No Power to the Unit (Mains Only)**

- Check the mains block fuse and replace if blown.
- Check for any loose wires at the mains block, the transformer and the AC terminals on the PCB.
- Check the mains block is connected correctly; live to live (brown), neutral to neutral (blue).

#### **No Power to the Unit (Battery Only)**

- Check the battery fuse F1 and replace if blown.
- Check for any loose wires at the BATT terminals on the PCB.
- Check that the battery wires are connected correctly; red from BATT+ to the battery positive (+), black from BATT- to the battery negative (-).

#### **No Power to the Unit (Mains & Battery)**

- Check the power supply output fuse F5 and replace if blown.
- Disconnect all wires from the control panel SAB A and AUX+ terminals.
- Check that links are only fitted in the correct places.
- Check there are no wires shorting to the underside of the PCB.
- Repeated blowing of the battery fuse F1 may indicate a faulty battery.

#### **Unit Does Not Accept Code**

- If using more than one RKP, check that each RKP has a different address.

- If using one or more RKPs, check that they are wired correctly.
- If the remote keypad was connected after the control panel was powered up, disconnect all power momentarily and reconnect. This automatically configures all remote keypads on the system, (also see page 24).
- Check you are using the correct codes. Factory-set Engineer code is ①②③④. Factory-set User code is ④③②①.
- If using one or more RKPs on battery only, try using mains as the battery may be flat.
- Check that the codes have not been changed. If the codes have been lost (see page 23).
- Check that the membrane keypad tail is all the way home in its connector on the PCB.

#### **Unit Will Not Set and Bleeps 10 Times**

The Power light on the panel will be flashing to indicate a power fault, either mains fail or battery low volts.

- The mains frequency may be set incorrectly (see page 22).
- The procedure for setting the system in the event of a power fault is described in the User Guide.

#### **Unit Will Not Set and Bleeps 9 Times**

The system has a tamper fault and the Tamper light will be on. Using the extended display during Walk Test (see page 23) identify the cause of the tamper fault:

- If the extended display identifies the fault as an EOL tamper then identify the zone(s) from the normal display and check the zone wiring.
- If the extended display identifies the fault as bell box tamper, then the cause may either be Bell Tamper or Global System Tamper. Temporarily replace the system tamper link (TAMP):
  - If the tamper fault persists then it is due to the Bell Tamper - check the bell wiring, the bell lid and/or screw tamper, and the bell wall tamper (if fitted).
  - If the tamper fault clears then it is due to the system tamper. Remove the system tamper link and the tamper fault will reappear - check the system tamper wiring and the lid tamper on all detectors.

#### **Remove ALL Temporary Links.**

- If the extended display identifies the fault as lid tamper, it may refer either to the control panel or the remote keypad(s). Try stretching the springs and ensure all connections are secure.
- To set the system with a tamper fault use the following procedure:
- **Enter the User code** ②②②②. **Press** **FULL** or **PART**. The system will sound a repeating series of 9 bleeps. **Press** **OMIT**. The display will illuminate the zones that are about to be armed. **Press** ⑨. The

- Tamper light will turn off. Press **PROG.**. The exit tone and exit timer will start.
- To prevent repeated false alarms due to an intermittent tamper fault when the system is unset, omit Tamper as described above, then abort the setting procedure by re-entering the User code.
- To prevent Tamper from being omitted (see page 21).

#### **Unit Will Not Set and Bleeps 1 - 8 Times**

The system has one or more zone faults and the corresponding zone light(s) will be on.

- Ensure that the zone is closed (doors shut, no movement in PIR detection area).
- Check the zone wiring and ensure all connections are secure.
- Check that detectors are powered correctly (i.e. correct polarity).

#### **Unit Goes Into False Alarm**

- Check that the terminal screws are fully down on all terminals **but do not over tighten**.
- If you have a meter use it to check the loop resistance (wires that run under carpets are easily damaged).

#### **Unit Makes No Sound**

- Check that the variable resistor (pot) on the PCB which controls the volume of low level tones is NOT turned fully clockwise. The volume increases as the pot is turned anti-clockwise.
- Check the auxiliary fuse F3 and replace if blown.
- Check the speaker connections to the L/S terminals on the PCB.

#### **System Operates but Keypad Makes No Sound**

- If an older version remote keypad has been fitted the system must be programmed for old style sounds as follows: **Enter the Engineer code ? ? ? ?**, press **PROG.**, **enter 0 0**, **press 8**, **press PROG.**, **press RESET**.

#### **External Sounder/Strobe Does Not Work**

- Check wiring connections by referring to the diagrams on page 15.
- Check the bell/strobe fuse F2 and replace if blown.
- To check the external sounder make a temporary connection between SAB B and D.
- To check the strobe make a temporary connection between SAB S and D.

#### **The Panic Button Does Not Work**

- Check that the Zone Type of the zone to which the panic button is connected is programmed as PA (see page 26).
- Check that the zone to which the panic button is connected is not omitted in part set (see page 30).

- Check that the Zone Type of the zone to which the panic button is connected is not changed in part set (see page 26).
- Older version remote keypads do NOT support Keypad PA (pressing 3 and 9 together), see System Operates but Makes No Sound, above.

#### **Service Timers Cannot Be Programmed**

Programming the service timers (27), (28), (29) is prevented unless the current date (25) has been programmed since the last power-up (see page 27).

# 4. Programming the Control Panel

## Introduction

Programming is usually unnecessary as the factory settings have been carefully selected to suit most installations without alteration. However all functions are fully programmable for Complete Control.

### The Programming Menu (00) - (98)

The Programming Menu can only be accessed when the control panel is unset.

The display will normally look like this:



Enter your 4-digit Engineer code (factory set to 1234). The display will look like this:



**NOTE** If no keys are pressed, the display will revert back to normal after 16 seconds.

Press **PROG.**, the display will look like this:

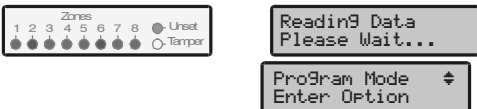

The various programming options are then selected by entering a 2-digit Option code (?). The Programming Procedure then depends upon the programming option selected as detailed in the following sections. On completion, each programming option reverts to the Programming Menu, allowing other programming options to be accessed. To exit the Programming Menu **press RESET**, the system will revert to unset.

**NOTE** To abort programming at any stage (and preserve the original setting) press **RESET**, the system will revert to the Programming Menu.

24 Hour zones (Fire, PA and Tamper) are disabled when the Programming Menu is accessed via an Engineer code.

To omit zones, set chime or change the User code, refer to the User Guide.

**The system programming is retained even in the event of complete loss of power.**

### Programming With an LCD Keypad

There are two ways to select options whilst in the Programming mode:

1. Select an option directly by entering a 2-digit Option code (?).

**NOTE** All of the programming examples shown in this section use this method of programming.

2. Using the **↕** key to scroll up and down through the menu options and then pressing **Yes** or **Prog.** to access the menu options.

**NOTE** Wherever a **↕** symbol appears on the display, the **↕** key can be used to search through the various menu options. The **Yes** or **Prog.** key can then be used to select the displayed option.

### Available LCD Menus

There are two ways to select options whilst in the Programming mode:

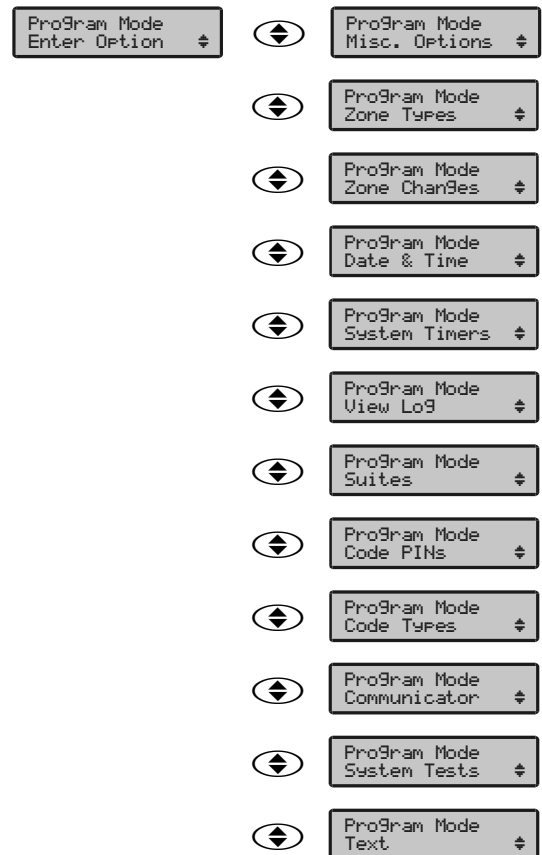

**The Miscellaneous Selections** 00 - 03

There are four sets of Miscellaneous Selections that control the behaviour of various system functions.

**Miscellaneous Selections Zero** 00

From the Programming Menu, enter 00. The display will show the options currently selected.



Press the appropriate numbered button(s) to select or de-select the corresponding option(s) as shown on the display.

**NOTE** To display an explanation of the Misc. options associated with a particular number, press and hold the corresponding key ? (LCD Keypad only).

Press (PROG). The system will chime to confirm that the new options have been accepted. The system will then automatically revert to the Programming Menu.

Option	Miscellaneous Selections Zero	Default
1	Cancel Strobe with Bell	Off
2	Keypad PA, 3 and 9	Off
3	Single Button Setting	On
4	Silent Part Set Confirmation Tone	Off
5	EN50131-1 Requirements	Off
6	Time Limit Engineer Access	Off
7	Reset Button Cancels Setting	On
8	Auto Omit AC	Off

**Option 1 - Cancel Bell With Strobe**

When 'ON' the strobe will stop when the bell timer expires.

**Option 2 - Keypad PA, 3 and 9**

When 'ON' Pressing 3 and 9 together will generate a keypad PA alarm.

**Option 3 - Single Button Setting**

When 'ON' The system can be set using the (FULL) or (PART) keys without the need to first enter a User code.

**Option 4 - Silent Part Set Confirmation Tone**

When 'ON' a confirmation tone is generated to indicate that the alarm has set, Will only function if Silent Part Set (see page 20) is also selected.

**Option 5 - EN 50131-1 Requirements**

When 'ON' the following features are enabled (see page 37).

1. Reset (after an alarm) requires the use of a User code.
2. An entry alarm (defined as an entry timeout or, a Guard zone activation during the entry period) invokes a 30 second delay during which the communicator output and external sounder are suppressed (i.e. the alarm response is limited to the internal sounder(s) and external strobe for the first 30 seconds).
3. On unsetting the system the unset light will extinguish after 30 seconds.
4. On unsetting the system omitted zones are re-included.

**Option 6 - Time Limit Engineer Access**

When 'ON' the control panel will only accept Engineer codes for the first 30 seconds after the system is unset (i.e. while the Unset light is on if Option 5 is also selected).

**Option 7 - Reset Button Cancels Exit**

When 'ON' setting can be aborted by pressing the (RESET) button. It is particularly useful if Single Button Setting (Option 3) is selected but may be used independently.

**Option 8 - Auto Omit AC**

When 'ON' an AC Mains fail is automatically omitted at the time of arming.

**NOTE** This option alleviates the need, for the customer to manually omit an AC Mains Fail, fault condition.

**Miscellaneous Selections One** 01

From the Programming Menu, enter 01. The display will show the options currently selected.



Press the appropriate numbered button(s) to select or de-select the corresponding option(s) as shown on the display.

**NOTE** To display an explanation of the Misc. options associated with a particular number, press and hold the corresponding key ? (LCD Keypad only).

Press (PROG). The system will chime to confirm that the new options have been accepted. The system will then automatically revert to the Programming Menu.

Option	Miscellaneous Selections One	Default
1	Internals Only on Unset Tamper Alarm	On
2	Internals Only on Part Set Zone Alarm	On
3	Internals Only on Part Set Tamper Alarm	On
4	Silent Part Set (no exit tone on part set)	Off
5	High Level Chime (chime at full volume)	Off
6	Invert Bell Output	Off
7	Final Door Set	Off
8	Unlock Engineer	On

**Option 1 - Internals Only on Unset Tamper Alarm**

When 'ON' a tamper alarm when unset will only activate the internal sounders.

**Option 2 - Internals Only on Part Set Zone Alarm**

When 'ON' an alarm when part set will only activate the internal sounders.

**Option 3 - Internals Only on Part Set Tamper Alarm**

When 'ON' a tamper alarm when part set will only activate the internal sounders.

**Option 4 - Silent Part Set**

When 'ON' no exit tones will be heard when the alarm is being part set.

**Option 5 - High Level Chime**

When 'ON' chime tones are always full volume.

**Option 6 - Invert Bell Output**

When 'ON' the bell output will be negative removed instead of negative applied.

**Option 7 - Final Door Set**

When 'ON' the alarm will set 3 seconds after the entry/exit door is closed.

**Option 8 - Unlock Engineer Code**

When 'ON' Re-loading the Factory Settings WILL restore the default Engineer code. If Option 8 is de-selected (Zone 8 light is off) then Re-loading the Factory Settings WILL NOT restore the default Engineer code.



Locked Engineer codes cannot be unlocked without the correct Boss Engineer code.



**Disclaimer**

It is the responsibility of the Installer to guard against losing locked Engineer codes. Texecom accept no liability whatsoever for any loss resulting from locked Engineer codes.

**Miscellaneous Selections Two**



From the Programming Menu, enter ②. The display will show the options currently selected.

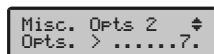

Press the appropriate numbered button(s) to select or de-select the corresponding option(s) as shown on the display.



To display an explanation of the Misc. options associated with a particular number, press and hold the corresponding key ② (LCD Keypad only).

Press (PROG.). The system will chime to confirm the new options have been accepted. The system will then automatically revert to the Programming Menu.

Option	Miscellaneous Selections Two	Default
1	Engineer Reset on Any Alarm	Off
2	Engineer Reset on Tamper Alarm	Off
3	Disable User Ability to Omit Tamper	Off
4	Code PIN Tamper	Off
5	Random Number Remote Reset	Off
6	Push To Set	Off
7	Strobe Flash on Full Set	On
8	Invert Switched Positive Output	Off

**Option 1 - Engineer Reset on Any Alarm**

When 'ON' the user is prevented from resetting the system after an alarm activation.

**Engineer Reset can be cleared by:**

- Entering an Engineer code
- Entering an RNRR code (if selected - Option 5)
- Remote Reset (if selected - see page 34)



Engineer Reset is not in itself a method of resetting the system a subsequent User Reset will still be required as follows:

**After an Alarm has been Silenced:**

- Pressing (RESET) (unless EN 50131-1 Requirements is selected - see page 20)
- Entering a User code

**At other times:**

- Entering a User code and pressing (RESET)



When an Engineer Reset is required the user can still silence the alarm and cancel the strobe but cannot reset the system.

RNRR and Remote Reset are methods of clearing Engineer Reset. They will not function unless at least one Engineer Reset is selected.

**Option 2 - Tamper Alarm Engineer Reset**

When 'ON' the user is prevented from resetting the system after a tamper alarm has occurred (for details on Engineer Reset see Option 1).

**Option 3 - Disable User Ability to Omit Tamper**

When 'ON' users cannot omit tamper.

**Option 4 - Code PIN Tamper**

When 'ON' a tamper alarm is generated after 16 invalid key presses when unset.

**Option 5 - Random Number Remote Reset**

When 'ON' Random Number Remote Reset is enabled.

- If RNRR (sometimes called Anti-Code Reset or Scramble Reset) is enabled and an Engineer Reset is required, a random 4-digit number will be displayed.



LED Keypad - Each digit will flash in turn and then pause before repeating.

LCD Keypad - A 4-digit number is displayed.

Texecom's Anti-Code software will accept this sequence to generate a 4-digit code, which should be entered, after which the system can be reset as normal. Anti-Code software is available from Texecom.

The user can press (RESET) to toggle between the RNRR and the alarm display.

The User Guide has a section to fill in the phone number(s) where the user may obtain the Anti-Code.

Random Number Remote Reset satisfies the requirements of NACP 10, Issue 2, Section 11.2b.

**Option 6 - Push To Set**

The user starts full set in the usual way and leaves the premises. However the system will ONLY set when an external push button is pressed.

**NOTE** Ensure the zone is set as Push to Set (see page 25).

If this zone is set to chime (see User Guide) then the push button can double up as a door bell.

If a normally open (N/O) push button is used then the zone should be inverted (see page 31).

Push to Set does not operate in part set.

**Option 7 - Strobe Flash on Full Set**

When 'ON' the external strobe will flash momentarily to indicate that the alarm has set.

**Option 8 - Invert Switched Positive Output**

When 'ON' the operation of the Switched Positive output (SW+) is inverted.

**Miscellaneous Selections Three** ① ③

From the Programming Menu, enter ① ③. The display will show the options currently selected.



Press the appropriate numbered button(s) to select or de-select the corresponding option(s) as shown on the display.

**NOTE** To display an explanation of the Misc. options associated with a particular number, press and hold the corresponding key (LCD Keypad only).

Press (PROG). The system will chime to confirm that the new options have been accepted. The system will then automatically revert to the Programming Menu.

Option	Miscellaneous Selections Three	Default
1	Mains Frequency (off = 50Hz, on = 60Hz)	Off
2	EOL Tamper Alarm on Zone Short	Off
3	EOL Tamper Alarm on Zone Open	Off
4	Enable DD 243:2002 Options	Off
5	Enable Confirmation After Entry Time Out	Off
6	Momentary KEYSW	Off
7	Automatically Omit Zone on Alarm	Off
8	Automatically Omit Keyswitch Zone when EOL Tampered	Off

**Option 1 - Mains Frequency**

When 'OFF' the Mains frequency is set to 50Hz (UK).

**NOTE** If the wrong Mains Frequency is selected the panel will indicate a power fault.

**Option 2 - EOL Tamper Alarm on Zone Short**

For details see page 13.

**Option 3 - EOL Tamper Alarm on Zone Open**

For details see page 13.

**Option 4 - Enable DD 243:2002 Options**

When 'ON' Opening the initial entry door disables ALL means of confirmation throughout the protected premises.

When the Confirmation timer expires, the Intruder Alarm output will restore, the next detector to activate will then cause the Intruder Alarm output to re-activate and the Confirmation Timer to restart.

When the DD 243:2002 option is enabled, owing to the ability to disable ALL of the confirmation facilities, the customer should be advised in writing by the alarm company that ALL means of confirmation are disabled when the initial entry door is opened. The alarm company should then obtain written acceptance from the customer of the disabling of the means of confirmation.

**Option 5 - Enable Confirmation After Entry Time Out**

When 'ON' confirmation is ONLY disabled for the duration of the Entry Time and is RE-ENABLED once the Entry Time has expired, after which activation of a further two zones must occur before the Confirmation output will activate.

**NOTE** This option is only applicable if Miscellaneous Selection 03, Option 4 is enabled.

**Option 6 - Momentary KEYSW**

When 'ON' any zone programmed as 'Keyswitch' will operate as follows:

- Changing the state of the zone i.e. closed to open or open to closed will cause the system to set and changing the state of the zone again i.e. closed to open or open to closed will cause the system to unset.
- If there has been an alarm activation, the next open close of the Keyswitch will cause the system to enter Recall and the next open close will Reset the panel and return it to Unset.

**Option 7 - Automatically Omit Zone On Alarm**

When 'ON' the system will prevent multiple alarms from the same zone. It should NOT be used if selecting non-latching communicator outputs (see page 34).

**Option 8 - Automatically Omit Keyswitch Zone**

When 'ON' a key switch cannot be used to unset the system if it is tampered with.

**Number of Alarm Activations (Re-arms)** ① ④

From the Programming Menu, enter ① ④. The display will look like this.



Enter the desired number of Alarm Activations as a two digit number (e.g. for three Activations, enter ① ③). The display will indicate as each digit is entered. Press (PROG). The control panel will chime to confirm that the new number of Activations has been accepted. The system will then automatically revert to the Programming Menu.

**NOTE** The total number of Activations should not be less than 01.

**Testing the Sounders, Strobe** ① ⑤

From the Programming Menu, **enter** ① ⑤. The display will look like this.



The system outputs may be tested as follows:

Key	Function
⑥	Invoke bell box hold-off mode
⑤	Toggle the SW+ output
④	Toggle the internal sounder high level (alarm tone)
③	Toggle the internal sounder low level (entry/exit tone)
②	Toggle the strobe output
①	Toggle the external sounder (bell) output
①	Turn off all of the above

**NOTE** The zone corresponding to each output will be displayed when it is on. Several Texecom bell boxes feature a unique, patented "Engineer Hold-Off Mode" which disables Self-Activate on Lid Tamper to facilitate convenient servicing. Option ⑥ will cause the strobe output to pulse 3 times to invoke Hold-Off Mode. Zone 2 will flash to indicate the strobe pulsing after which Zone 6 will indicate that Hold-Off Mode has been invoked. (See bell box instructions for more details).

**Press** **RESET** to return to the Programming Menu.

**Walk Testing** ① ⑥ or ① ⑨

The control panel has two Walk Test modes, Latching and Non-Latching. During Walk Test when any zone is opened the corresponding zone will indicate. When the zone is closed the zone indication will clear in Non-Latching Walk Test, but will remain on in Latching Walk Test.

From the Programming Menu, **enter** ① ⑥ to select **Non-Latching Walk Test**, or ① ⑨ to select **Latching Walk Test** followed by **PROG.**



Initially all the zone indicators will be off and the control panel will sound the quiet exit tone. When any zone is opened, the corresponding zone will indicate. The control panel will, in addition, sound a repeating series of beeps corresponding to the open zone number (i.e. Zone 1 beeps once, Zone 2 beeps twice, etc.). If more than one zone is open, the beeps will correspond to the highest zone number (e.g. if Zone 2 and Zone 6 are open, the control panel will beep 6 times).

Conduct a Walk Test by triggering each of the system's detection devices in turn and check that the control panel registers the corresponding zone as open.

**NOTE** If the Tamper indicator is on and the panel beeps 9 times an extended display reveals more information about the source of the tamper fault(s). To toggle between the normal display and the extended display **press** **OMD**. The extended display is distinguished from the normal display by the Unset light being off. In the extended display the zones are interpreted as follows:

Zone	Description
1	Bell Tamper (including Global System Tamper)
2	Not Applicable
3	Lid Tamper (including RKP Lid Tamper)
4	Line Monitor
5	RKP Off-Line
6	Not Applicable
7	Not Applicable
8	EOL Tamper

To terminate Walk Test **press** **RESET**. The system will return to the Programming Menu.

**NOTE** Silent PA zones (see page 25) are only displayed if Walk Test is accessed via an Engineer code.

**Re-Loading the Factory Settings** ① ⑦

From the Programming Menu, **enter** ① ⑦. The display will look like this.



**Press** **PROG.** The system will chime to confirm that all the factory settings have been re-loaded into the Non Volatile Memory. The system will then automatically revert to the Programming Menu.

If the Engineer code has been lost, provided it has not been locked (see page 20) **power down the system** (mains and battery). **Restore power**. The display will look like this for 10 seconds.



**Press** **RESET**, or SLOWLY press and release the panel lid tamper spring 3 times, before this display changes. The factory settings have now been re-loaded into the Non Volatile Memory.

**NOTE** Re-loading factory settings will not clear the Event Log (see page 29). The system will beep each time the panel lid tamper spring is pressed and released during the first 10 seconds after power up.

**Programming the SW+ Output** ①⑧

From the Programming Menu, **enter** ①⑧. The display will show the option currently selected.



Press the number of the function required from the following list. Press **PROG.**

The system will chime to confirm the new function has been accepted. The system will automatically revert to the Programming Menu.

Option	SW+ Function
1	Set Positive (latching detectors)
2	Alarm Positive with Latching Sensor Reset (FTA detectors)
3	Latching Shock Sensor Auto-Reset (old style latching shock sensors)
4	Tamper
5	Mains Fail
6	Set Positive with Latching Sensor Reset (latching detectors)
7	Walk Test
8	Entry/Exit

If connecting multiple detectors to one zone then:

- Latching detectors will indicate which detector(s) activated during an alarm.
- First to Alarm (FTA) detectors will indicate which detector caused an alarm and which detectors were then activated during the alarm.

Option 3 would typically be used with older designs of latching shock sensor which do not have a Latch input and must be powered down to clear the Latch indication. In this case the detectors would be powered from the SW+ output.

**NOTE** If selecting one of the options which incorporate latching sensor reset (2, 3 or 6) the user can force a latching sensor reset, to clear the Latch/FTA indication, **by entering their code and pressing** **RESET**.

**NOTE** The SW+ output can only sink (not source) current. If powering detectors from the SW+ output, connect the detector +Ve to AUX+ and the detector -Ve to SW+. It may be necessary to invert the SW+ polarity (see page 21).

**Configuring Remote Keypads** ①⑨

When the system is powered up it automatically checks and configures all connected keypads. It is strongly recommended that the system is completely powered down (mains and battery) before wiring a keypad. If a keypad is added without removing power then it must be configured as described below.

From the Programming Menu, **enter** ①⑨. The display will show the zone numbers corresponding to remote keypads (RKPs) that are currently configured and on-line, while flashing the zone numbers corresponding to RKPs that are currently configured but off-line.



To update the configuration, **press** **PROG.** The control panel will scan for RKP addresses 1 to 6. As each RKP is detected the control panel will configure it as present and show the zone number corresponding to its address.

To leave configuring, **press** **RESET**. If the configuration has not been updated the panel will sound an error tone. The system will automatically revert to the Programming Menu.

**NOTE** NEVER set two RKPs to the same address. Setting the address of an RKP is described in the remote keypad instructions. If an RKP is configured but off-line the system will have a tamper fault. ALWAYS power down the control panel when wiring a remote keypad (RKP).



## Programming Zone Types

①① - ①⑧

The Zone Type of a zone determines how the system will behave when the zone is opened.

### Description of Zone Types

The Control Panel supports eight different Zone Types. Each zone may be programmed with one of these Zone Types which are described as follows:

#### Push To Set

Push to Set is intended to reduce false alarms due to user error when full setting the system. The user starts full set in the usual way and leaves the premises. However the system will ONLY set when an external push button is pressed. The Zone Type of the zone to which the external push button is connected must be programmed as Push to Set.



**NOTE** The Push to Set option must also be selected (see page 21).

*If a normally open (N/O) push button is used then the zone should be inverted (see page 31) so that it chimes when the button is pressed rather than when it is released.*

*If the zone is set to chime (see User Guide) then the push button can double up as a doorbell.*

*The external push button should be waterproof unless it is located in an enclosed porch.*

*Push to Set does not operate in part set.*

*Push to Set satisfies the requirements of NACP 14, Issue 1, Section 2.1.2.*

#### Inhibited Entry

Inhibited Entry is sometimes referred to as 'Intermediate Entry' or 'Walk Through'. Opening a zone with this Zone Type when the panel is set will cause an alarm. During entry mode, activations of a zone with this Zone Type are disregarded. This Zone Type would typically be used for a hall PIR when there is a magnetic contact on the front door.

#### Guard

Guard zones are sometimes referred to as 'Intruder' zones. Opening a zone with this Zone Type when the system is set will cause an alarm. When the control panel is unset, Guard zones are ignored. In a typical system most zones would have this Zone Type.

#### Fire

This Zone Type is designed specifically for smoke detectors. Zones with this Zone Type are monitored constantly even when the panel is unset. If activated they will cause a unique alarm with a distinctive 'Fire' tone on the internal speaker. In addition, the external sounder will be pulsed rather than sounding continuously in contrast to a normal alarm.

#### Tamper

Zones with this Zone Type are monitored constantly even when the panel is unset. If activated they will cause an immediate alarm. The Global System Tamper zone is factory-set to this Zone Type.



**NOTE** Programming options allow the Tamper alarm response to be limited to the internal sounder if the system is unset or part set (see page 20).

#### Entry/Exit

Opening a zone with this Zone Type when the system is set will cause the control panel to start entry mode. This Zone Type would typically be used for a front door magnetic contact or, if one is not fitted, a hall PIR.



**NOTE** The Final Door Set option (see page 20) will cause the exit time to be reduced to 3 seconds when an Entry/Exit zone is closed during exit mode. This option would typically be used only when there is a magnetic contact on the front door.

#### Personal Attack

This Zone Type is designed specifically for panic buttons. Zones with this Zone Type are monitored constantly even when the panel is unset. If activated, they will cause an immediate alarm, sounding both the internal and external sounders.



**NOTE** The Silent PA option (see page 34) will modify this Zone Type to have a silent response (just activation of the PA channel on the communicator interface with no local audible or visible alarm response at all).

#### Keyswitch

This Zone Type is designed specifically for key switches. Zones with this Zone Type are monitored constantly. The key switch can be used to full set, unset, silence an alarm and reset the system.



**NOTE** Ensure that there are no 24 Hour zones (Fire, PA and Tamper) in fault when using a key switch to reset the system.

*A Keyswitch zone can be programmed to operate in one of two ways (see page 22).*

*Changing the state of the zone i.e. closed to open or open to closed will cause the system to set and changing the state of the zone again i.e. closed to open or open to closed will cause the system to unset.*

*Activating the zone i.e. closed to open will cause the system to set and clearing the zone again i.e. open to closed will cause the system to unset.*

*PA codes, Duress codes and Keypad PA are entered from a keypad and therefore cannot be reset by a key switch but only by entry of a valid User code.*

**24 Hour Zone Types**

24 Hour zones (Fire, PA and Tamper), Keyswitch zones and Push to Set zones should be monitored constantly.

When a zone is omitted the system no longer monitors opening and closing of that zone. The Full and Part Set Suites (see page 30) provide a method of automatically omitting zones when the system is set. Once a zone is omitted it will not be re-included until the system is next set. It is important to ensure that 24 Hour zones (Fire, PA and Tamper), Keyswitch zones and Push to Set zones are not omitted by any of the Full or Part Set Suites or the Cleaner Suite.

The system can be programmed to automatically change the Zone Type of any zone into either Exit/Entry, Inhibited Entry or Guard on selected part sets (see page 26). The change will persist until the system is unset. It is important to ensure that 24 Hour zones (Fire, PA and Tamper), Keyswitch zones and Push to Set zones are not changed on part set.



**NOTE** If EN 50131-1 Requirements is selected (see page 20) then omitted zones will be reinstated when the system is next unset.

When wiring a 24 Hour zone (Fire, PA and Tamper), such as a panic button, using EOL operation it may be more convenient to fit the EOL resistor(s) in the panel than in the detector.

**Programming the Zone Type** ①① - ①⑧

Each of the eight Zone Types has an associated Zone Type number which is used when programming the Zone Type of a zone:

Zone Type Number	Zone Type
1	Push to Set
2	Inhibited Entry
3	Guard
4	Fire
5	Tamper
6	Entry/Exit
7	Personal Attack (Panic)
8	Keyswitch

From the Programming Menu, **press ① followed by the zone number**. The Zone Type currently selected will indicate i.e. Guard.

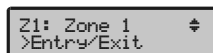

**Press the Zone Type number required. Press (PROG).** The system will chime to confirm the new Zone Type has been accepted. The system will then automatically revert to the Programming Menu.

For example to program Zone 7 as a Guard zone, enter ①⑦, press ③, press (PROG).

Key	Description
①	Program Zone Type
⑦	Zone = 7
③	Zone Type = Guard
(PROG)	Program



**NOTE** A zone is often referred to by its Zone Type, e.g. a zone with the PA Zone Type would be referred to as a PA zone.

**Changing Part Set Zone Types** ②① - ②③

The Zone Type of any zone can be made to change when the system is part set. The Zone Type can be changed into either Entry/Exit, Inhibited Entry or Guard. It is also possible to program which part set(s) will cause the Zone Type to change. The change will persist until the system is next unset.

For example, the tables below show the factory settings:

Zone	Zone Type	Part Setting Changes Zone Type Into:		
		Entry/Exit ②①	Inhibited Entry ②②	Guard ②③
1	Entry/Exit			③
2	Inhibited Entry	③		
3	Guard			
4	Guard			
5	Guard			
6	Guard			
7	Guard			
8	Guard			

Zone 1 will change (from Entry/Exit) into Guard and Zone 2 will change (from Inhibited Entry) into Entry/Exit.

Part Set Number ②①	Zone Type Changes For Part Set
Part Set 1	③
Part Set 2	
Part Set 3	③
Part Set 4	

These changes will occur when using Part Sets 1 and 3 but not when using Part Sets 2 and 4.



**NOTE** 24 Hour zones (Fire, PA and Tamper), Keyswitch zones and Push to Set zones should be monitored constantly and should NOT be programmed to change when the system is part set.

**Programming Part Sets Zone Changes** ②①

The Control Panel has four part sets. Zone Types will only be changed on selected part sets. For example the Control Panel is factory set with Part Sets 1 and 3 selected. Thus Zone Types will only be changed on Part Set 1 and Part Set 3, not on Part Set 2 or Part Set 4.

From the Programming Menu, enter ②①. The part sets currently selected will indicate.



Press the appropriate numbered button(s) of the part set(s) to be selected or de-selected. Press **PROG.** The system will chime to confirm that the new selection has been accepted. The system will then automatically revert to the Programming Menu.

**Changing Zones to Entry/Exit** ②①

This suite defines the zones which will be changed into Entry/Exit zones on the selected part sets. For example the Control Panel is factory set with Zone 2 included. Thus the Zone Type of Zone 2 will be changed (from Inhibited Entry) into Entry/Exit on Part Sets 1 and 3.

From the Programming Menu, enter ②①. The zones that are currently included will indicate.



Press the appropriate numbered button(s) of the zone(s) to be included or excluded. Press **PROG.** The system will chime to confirm that the new suite has been accepted. The system will then automatically revert to the Programming Menu.

**Changing Zones to Inhibited Entry** ②②

This suite defines the zones which will be changed into Inhibited Entry zones on the selected part sets. For example the Control Panel is factory set with no zones included. Thus no zones will be changed into Inhibited Entry.

From the Programming Menu, enter ②②. The zones that are currently included will indicate.



Press the appropriate numbered button(s) of the zone(s) to be included or excluded. Press **PROG.** The system will chime to confirm that the new suite has been accepted. The system will then automatically revert to the Programming Menu.

**Changing Zones to Guard** ②③

This suite defines the zones which will be changed into Guard zones on the selected part sets. For example the Control Panel is factory set with Zone 1 included. Thus the Zone Type of Zone 1 will be changed (from Entry/Exit) into Guard on Part Sets 1 and 3.

From the Programming Menu, enter ②③. The zones that are currently included will indicate.



Press the appropriate numbered button(s) of the zone(s) to be included or excluded. Press **PROG.** The system will chime to confirm that the new suite has been accepted. The system will then automatically revert to the Programming Menu.

**Programming the Date and Time** ②⑤ - ②⑥

**NOTE** It is **ESSENTIAL** to program the current date (②⑤) and time (②⑥) for correct operation of the service timer(s) and the 250 Event Extended Log.

Programming the service timers (②⑦, ②⑧, ②⑨) is prevented unless the current date (②⑤) has first been programmed.

If the panel is completely powered down it will attempt to store the current time and date in NVM and continue from this point when it is powered up. However it may be also desirable to select the Engineer Reset on Power Up option (see page 21).

**Programming the Date** ②⑤

From the Programming Menu, enter ②⑤. The display will look like this.



Enter the current date as a 6 digit number; **Day, Day, Month, Month, Year, Year** (e.g. to program the 1st of June 1998 enter ①①①⑥⑨⑧). The display will indicate as each digit of the new date is entered. Press **PROG.** The system will chime to confirm the new date has been accepted. The system will then automatically revert to the Programming Menu and all the zone lights will illuminate.

**Programming the Time** ②⑥

From the Programming Menu, enter ②⑥. The display will look like this.



Enter the current time as a 6 digit number; Hour, Hour, Minute, Minute, Second, Second using 24 hour format (e.g. to program 7 minutes and 3 seconds past 2pm (14:07:03) enter ①④⑦⑦③). The display will indicate as each digit of the new time is entered. Press (PROG.). The system will chime to confirm the new time has been accepted. The system will then automatically revert to the Programming Menu.

**Programming the Service Timers** ②⑦ - ②⑨



It is essential to program the current date (②⑤) and time (②⑥) for correct operation of the service timers.

Programming the service timers (②⑦), (②⑧), (②⑨) is prevented unless the current date (②⑤) has first been programmed.

The user can turn off chime globally or on individual zones but where still selected it will remain at high level until reprogrammed by an Engineer.

**Disclaimer:**

It is the responsibility of the Installer to obtain prior written agreement from the Customer regarding any use of a Service Timer. Texecom accept no liability whatsoever for any dispute resulting from the use of Service Timers.

The Control Panel features three service timers designed to facilitate the convenient support of service contracts.

Any one, any two, or all three timers can be programmed for the same or different dates. To disable a service timer simply program an invalid or expired date. Expired service timers are automatically cleared when an Engineer code is entered.

**Service Timer One - Reminder**

Service Timer One is designed to be used as a reminder. When it expires it turns on high level chime on all eight zones the first time the panel is set/unset.

**Service Timer Two - Nuisance**

Service Timer Two is designed to be used as a nuisance. When it expires it turns on high level chime on all eight zones every time the panel is set/unset.

**Service Timer Three - Lockout**

Service Timer Three is designed to be used as a lockout. When it expires it will turn chime off and the panel will require an Engineer Reset (see Option 1 page 21 for details on Engineer Reset).

**Programming Service Timer One** ②⑦

From the Programming Menu, enter ②⑦. The display will look like this.



Enter Service Timer One (Reminder) date as a 6 digit number; Day, Day, Month, Month, Year, Year (e.g. to program the 1st of April 1999 enter ①①④⑨⑨). The display will indicate as each digit of the new date is entered. Press (PROG.). The system will chime to confirm the new date has been accepted. The system will then automatically revert to the Programming.

**Programming Service Timer Two** ②⑧

From the Programming Menu, enter ②⑧. The display will look like this.



Enter Service Timer Two (Nuisance) date as a 6 digit number; Day, Day, Month, Month, Year, Year (e.g. to program the 25th of December 2000 enter ②⑤①②⑦⑦). The display will indicate as each digit of the new date is entered. Press (PROG.). The system will chime to confirm the new date has been accepted. The system will then automatically revert to the Programming Menu.

**Programming Service Timer Three** ②⑨

From the Programming Menu, enter ②⑨. The display will look like this.



Enter Service Timer Three (Lockout) date as a 6 digit number; Day, Day, Month, Month, Year, Year (e.g. to program the 1st of January 2001 enter ①①①①①①). The display will indicate as each digit of the new date is entered. Press (PROG.). The system will chime to confirm the new date has been accepted. The system will then automatically revert to the Programming Menu.

**Programming EOL Values** ③⑩



This option is only available on LED keypads

From the Programming Menu, enter ③⑩. Enter ①① for 10k/22k/33k operation or ② for 4K7/2K2 operation. Press (PROG.). The system will chime to confirm the new value been accepted. The system will then automatically revert to the Programming Menu.

**Programming System Timers** ③① - ③⑨

The system has the following eight time delays and one test time which are all programmable:

No.	Time Delay
①	Full Set Exit Time (seconds)
②	Part Set Exit Time (seconds)
③	Full Set Entry Time (seconds)
④	Part Set Entry Time (seconds)
⑤	Bell Cut Off Time (minutes)
⑥	Part Set Error Tone Suspension Time (seconds)
⑦	Bell Delay Time (minutes)
⑧	Confirmation Time (minutes)
⑨	Zone Soak Test Time (days)

To program any of the above, from the Programming Menu, **press ③ followed by the corresponding time delay number** (e.g. for the Part Set Entry Time, enter ③④). The display will look like this.



**Enter the desired time as a two digit number** (e.g. for 5 seconds enter ⑤⑤). The display will indicate as each digit is entered. **Press (PROG.)**. The system will chime to confirm the new time has been accepted. The system will automatically revert to the Programming Menu and all the zone lights will illuminate.

**NOTE** The Bell Delay Time ⑦ is the length of time after the alarm activation before the bell sounds. The Bell Cut Off Time ⑤ is the length of time for which the bell sounds.

The L/M input should be connected to 0V (AUX-) if not required, otherwise Bell Delay will not operate.

The Part Set Error Tone Suspension Time ⑥ would typically be used to suspend the error tone (indicating an open zone) to avoid disturbance when there are detectors on the part set exit route.

The Second Intruder Time ⑧ is the time after a zone opening during which a different zone opening will activate the Second Intruder output channel on the communicator interface.

The Zone Soak Test Time ⑨ is used in conjunction with the Zone Soak Test Suite (see page 30).

Some bell boxes have a built in timer. In this case the bell will sound for either its built in time or the programmed cut-off time, whichever is the shorter.

**The Seven Event Basic Log** ④① - ④⑦

The control panel has a Seven Event Basic Log which stores the last 7 alarm activations. The zone that caused the initial alarm activation will flash, and any subsequently opened zones will also be shown (not flashing).

The Control Panel also incorporates a time and date stamped, non-volatile, 250 Event Extended Log which can neither be erased nor altered. The 250 Event Extended Log can only be accessed using an LCD keypad or an interface available from Texecom.

**NOTE** The date (see page 27) and time (see page 28) must be programmed for the 250 Event Extended Log to function correctly.

**Clearing the Seven Event Basic Log** ④①

From the Programming Menu, **enter ④①**. The display will look like this.



**Press (PROG.)**. The system will chime to confirm that the Seven Event Basic Log has been erased. The system will then automatically revert to the Programming Menu.

**Displaying the Seven Event Basic Log** ④① - ④⑦

From the Programming Menu, **press ④ followed by the number corresponding to the desired event**, ① being most recent, ⑦ being least recent (e.g. to recall the second most recent event, enter ④②). The zone that caused the initial alarm activation will flash, and any subsequently opened zones will also be shown (not flashing).



If the Tamper indicator is on or flashing, an extended display reveals more information about the source of the tamper alarm. To toggle between the normal display and the extended display, **press (MNT)**. The extended display is distinguished from the normal display by the Unset light being off. In the extended display the zone indicators are interpreted as follows:

Zone Light	Description
1	Bell Tamper (including Aux Tamper)
2	Power Supply Fault
3	Lid Tamper (including RKP Lid Tamper)
4	Line Monitor
5	RKP Off-Line
6	Code PIN Tamper
7	Keypad PA (including PA Code Entered)
8	EOL Tamper

**Press (RESET)**. The system will return to the Programming Menu.

**Programming the Suites** ④⑧ - ⑤⑨

The system has a Full Set Suite, four Part Set Suites, a Chime Suite, a Cleaner Suite, a Double Knock Suite, a Manual Omit Suite, a Zone Invert Suite, a Zone Disable Suite and a Zone Soak Test Suite all of which are programmable.

24 Hour zones (Fire, PA and Tamper), Keyswitch zones and Push to Set zones should be monitored constantly and should NOT be omitted by the Full or Part Set Suites or the Cleaner Suite.

**Programming the Zone Disable Suite** ④⑧

The Zone Disable Suite defines the zones that are not monitored. Disabled zones cannot cause either alarm or EOL tamper. A zone could be disabled:

- If it was not being used.
- While waiting for a faulty detector to be replaced.

From the Programming Menu, enter ④⑧. The zones currently included in the Zone Disable Suite will indicate (zones not included will remain off).



Press the appropriate numbered button(s) of the zone(s) to be included or excluded. Press (PROG.). The system will chime to confirm that the new Zone Disable Suite has been accepted. The system will then automatically revert to the Programming Menu.

**NOTE** If a zone is disabled in this suite it will be necessary to enter the suite again to re-enable it.

**Programming the Zone Soak Test Suite** ④⑨

The Zone Soak Test Suite defines the zones that are on Soak Test.

Soak Test is used to prevent false alarms for a set period after a new installation or when a detector has been replaced. If a zone on Soak Test activates it will not cause alarm or activate the communicator interface but it will still be logged. Afterwards the zone will have a standing fault and will need to be omitted before the system can be set. After the Soak Test Time (see page 29) zones that have not activated will be automatically removed from the Soak Test Suite.

From the Programming Menu, enter ④⑨. The zones currently included in the Zone Soak Test Suite will indicate (zones not included will remain off).



Press the appropriate numbered button(s) of the zone(s) to be included or excluded. Press (PROG.). The system will chime to confirm that the new Zone Soak Test Suite has been accepted. The system will then automatically revert to the Programming Menu.

**NOTE** Soak Test is not appropriate for Entry/Exit, Push to Set, or Keyswitch Zone Types and these zones will still be

monitored as normal even if they are included in the Soak Test Suite.

Zones which fail Soak Test will be automatically added to the Manual Omit Suite (see page 31) which should be checked after a Soak Test failure.

When the Soak Test Suite is programmed the Soak Test Time is started therefore this should be programmed first (see page 29).

Zones that have failed Soak Test will be cleared when the Soak Test Suite is programmed.

If a Soak Test zone activates all subsequent zone activations will be logged as well. For example, zones 5, 6, 7 & 8 are on Soak Test. Zones 7 & 8 activate and are logged (zone indicator On). The user then returns via Zone 1, Zone 2 & Zone 3. These zones will all be logged as well but while Zone 2 & 3 indicators will be On, Zone 1 indicator will be Flashing as this was the first non Soak Test zone to be activated. It is therefore recommended that the 250 Event Extended Log is always checked in the event of a Soak Test failure.

**Programming the Full Set Suite** ⑤⑩

The Full Set Suite defines the zones that will be automatically included and excluded (omitted) when the system is full set.

From the Programming Menu, enter ⑤⑩. The zones currently active in full set will indicate (the omitted zones will remain off).



Press the appropriate numbered button(s) of the zone(s) to be included or excluded (omitted). Press (PROG.). The system will chime to confirm that the new Full Set Suite has been accepted. The system will then automatically revert to the Programming Menu.

**Programming the Part Set Suites** ⑤① - ⑤④

A Part Set Suite defines the zones that will be automatically included and excluded (omitted) when the system is part set.

From the Programming Menu, press ⑤ followed by the suite number ①, ②, ③, or ④ (e.g. to program Part Set Suite 2, enter ⑤②). The zones currently active in the selected part set will indicate (the omitted zones will remain off).



Press the appropriate numbered button(s) of the zone(s) to be included or excluded (omitted). Press (PROG.). The system will chime to confirm that the new Part Set Suite has been accepted. The system will then automatically revert to the Programming Menu.

**Programming the Chime Suite** (5) (5)

The Chime Suite defines the zones that will be automatically included and excluded (omitted) when chime is turned on.

From the Programming Menu, **enter** (5) (5). The zones that will chime when chime is turned on will indicate (zones that won't chime will remain off).



**Press the appropriate numbered button(s) of the zone(s) to be included or excluded. Press (PROG).** The system will chime to confirm that the new Chime Suite has been accepted. The system will then automatically revert to the Programming Menu.



*For a description of how to turn Chime on and off see the User Guide.*

**Programming the Cleaner Suite** (5) (6)

The Cleaner Suite defines the zones that will be armed/disarmed when the panel is set/unset with a Cleaner code.

From the Programming Menu, **enter** (5) (6). The zones currently included in the Cleaner Suite will indicate (zones not included will remain off).



**Press the appropriate numbered button(s) of the zone(s) to be included or excluded. Press (PROG).** The system will chime to confirm that the new Cleaner Suite has been accepted. The system will then automatically revert to the Programming Menu.



*The Entry/Exit zone which the cleaner will use MUST be included in the Cleaner Suite.*

*For a description of programming the Access Codes and Access Levels (see page 32).*

**Programming the Double Knock Suite** (5) (7)

The Double Knock Suite defines the zones that will be assigned the double knock attribute

From the Programming Menu, **enter** (5) (7). The zones currently included in the Double Knock Suite will indicate (zones not included will remain off).



**Press the appropriate numbered button(s) of the zone(s) to be included or excluded. Press (PROG).** The system will chime to confirm the new Double Knock Suite has been accepted. The system will automatically revert to the Programming Menu.



*A zone should be assigned a double knock attribute when maximum false alarm protection is required. A zone with a double knock attribute must be activated either twice within*

*10 seconds or once for longer than 10 seconds in order to cause an alarm.*

*Double knock is not recommended for Entry/Exit zones.*

*Double knock will not operate with Push to Set or Keyswitch zones.*

*Double knock should NOT be used for Fire, Panic, or Tamper zones.*

**Programming the Manual Omit Suite** (5) (8)

The Manual Omit Suite defines the zones that may be manually omitted by the user.

From the Programming Menu, **enter** (5) (8). The zones currently included in the Manual Omit Suite will indicate (zones not included will remain off).



**Press the appropriate numbered button(s) of the zone(s) to be included or excluded. Press (PROG).** The system will chime to confirm that the new Manual Omit Suite has been accepted. The system will then automatically revert to the Programming Menu.



*To prevent the user from omitting 24 Hour zones (Fire, PA and Tamper) these would be excluded from the Manual Omit Suite.*

*Zones not included in the Manual Omit Suite will still be omitted if they are excluded in the Full or Part Set Suites.*

**Programming the Zone Invert Suite** (5) (9)

The Zone Invert Suite defines the zones that are normally open (N/O) rather than normally closed (N/C).

From the Programming Menu, **enter** (5) (9). The zones currently included in the Zone Invert Suite will indicate (zones not included will remain off).



**Press the appropriate numbered button(s) of the zone(s) to be included or excluded. Press (PROG).** The system will chime to confirm that the new Zone Invert Suite has been accepted. The system will then automatically revert to the Programming Menu.



*Most detectors are normally closed (N/C).*

*The most common normally open (N/O) sensor is a pressure pad or push to set button.*

**Assigning Access Codes** ⑥⑩ - ⑦⑨

The Control Panel allows up to eight users to operate the alarm system, each user is assigned an “Access code”, “Access Level” and “User Number”. **The figure below shows an example of users assigned to a typical alarm system:**

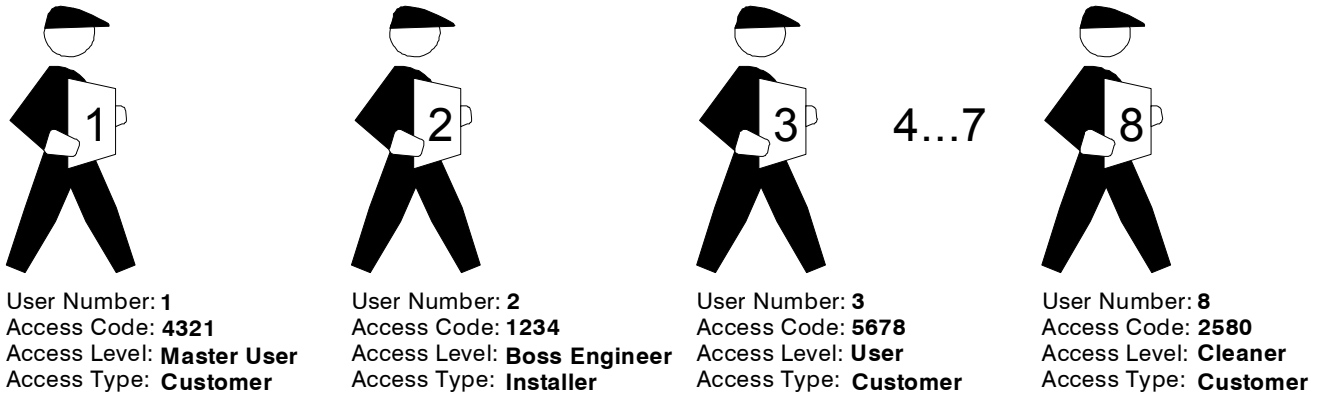

**User Number**

Each user is identified by the alarm system as User 1 through to User 8.

**Access Code**

Each user has a programmable 4 digit Personal Identification Number (PIN) which the user enters in order to operate the alarm system.

**Access Level**

Each user has a programmable Access Level that determines how the alarm system responds and which of the system facilities the user can access.

Each Access Level has an associated number (1 – 8) which is used when programming the Access Level of a user.

There are eight possible user Access Levels:

**User**

A User may set, unset, silence an alarm and reset the system. In addition a User can test the system outputs (see page 23), perform a Walk Test (see page 23) and view the Basic Log (see page 29). A User cannot change Access Codes (other than their own) or Access Levels.

**Engineer**

Engineers can access all the programming options with the exception of changing Access Codes (other than their own) or Access Levels.



*An Engineer cannot lock or unlock Engineer codes (see page 20).*

**Personal Attack**

Entering a PA code will cause an immediate alarm, sounding both the internal and external sounders.

**Duress**

A Duress code behaves exactly as a User code (Level 1) but will in addition activate the Duress channel on the communicator interface to secretly summon assistance.

**Master User**

A Master User may set, unset, silence an alarm and reset the system. In addition a Master can test the system outputs (see page 23), perform a Walk Test (see page 23) and view the Basic Log (see page 29). A Master User can also assign new Customer Access code and Access Levels.

**Cleaner**

If the system is full set or part set then a Cleaner code will automatically omit the Cleaner Suite zones (see page 31) without affecting the other zones. In addition pressing a key will NOT cause the system to start entry mode. On leaving the cleaner should enter their Access code and press either **FULL** or **PART**. The **OMIT** key is disabled and the previous set will be restored irrespective of which key was pressed. A cleaner cannot access chime. Nor can they cancel an alarm or reset the system.



*When a cleaner is setting the system the Cleaner Suite zones will flash indicating that they are currently omitted but are about to be re-included. Any other omitted zones (e.g. if the system was previously part set rather than full set) will also flash but will NOT be included.*

*A Cleaner code should NOT be used if no zones are included in the Cleaner Suite (see page 31).*

*If the system is unset then a cleaner can full set, part set and omit zones.*



**Null**

The Null level is the only level which can be changed both by a Master User and by a Boss Engineer. The Null level has two functions:



*If a user is no longer required, their Access Level should be changed to Null. This will erase the associated Access code.*

*To change a Customer Access Type to an Installer Access Type, or vice versa, it must first be changed to the Null Code Type.*

**Boss Engineer**

Boss Engineer level can access all the Engineer programming options and can also assign Access Level Engineer (Level 2).

**Access Types**

There are two Access Types, Customer and Installer. The Boss Engineer Level can only program the Installer Types. The Master User Level can only program the Customer Types.

The table below shows a summary of each Access Level and who is responsible for assigning the Level:

Access Level	Access Level Number	Access Type	Can be Programmed by
User	①	Customer	Master ④③②①
Engineer	②	Installer	Boss ①②③④
PA (Panic)	③	Customer	Master ④③②①
Duress	④	Customer	Master ④③②①
Master User	⑤	Customer	Master ④③②①
Cleaner	⑥	Customer	Master ④③②①
Null	⑦	Customer Installer	Master ④③②① Boss ①②③④
Boss Engineer	⑧	Installer	Boss ①②③④



*The Master User can only assign Customer Access Types and the Boss Engineer can only assign Installer Access Types.*

**Changing Your Own Access Code** ⑥①

Each user has a programmable 4 digit Personal Identification Number (PIN) which the user enters in order to operate the alarm system.

Every user has the ability to change their own 4 digit Access code, as follows:

From the Programming Menu, enter ⑥①. The display will look like this.



Enter the new Access code ②②②②. The display will indicate as each digit of the new code is entered. Press (PROG), the system will chime to confirm the new code has been accepted. The system will then automatically revert to the Programming Menu.

**Assigning New Access Codes** ⑥① - ⑦⑧

The Master User can assign a new Access code or change an existing Access code providing it is a Customer Type. The Boss Engineer can assign a new Access code or change an existing Access code providing it is an Installer Type.

**Programming Access Codes** ⑥① - ⑥⑧

From the Programming Menu, enter ⑥ followed by the User Number ① to ⑧ i.e. for User 5, enter ⑥⑤. The display will look like this.



Enter the new Access code ②②②②. The display will indicate as each digit of the new code is entered. Press (PROG), the system will chime to confirm the new code has been accepted. The system will then automatically revert to the Programming Menu.

**Programming Access Levels** ⑦① - ⑦⑧

From the Programming Menu, enter ⑦ followed by the User Number ① to ⑧ i.e. for User 5, enter ⑦⑤. The display will show the Access Level currently selected.



Press the number of the Access Level required ②, i.e. for User, enter 1. Press (PROG), the system will chime to confirm the new Access Level has been accepted. The system will then automatically revert to the Programming Menu.

**Displaying User Information** (6) (9) & (7) (9)

Each user is identified by the alarm system as User 1 through to User 8. Every user may view their User Number (1 - 8) or their own Access Level as follows:

**Displaying Your User Number** (6) (9)

From the Programming Menu, **enter** (6) (9). The zone corresponding to your User Number will show



Press **(RESET)**, the system will then automatically revert to the Programming Menu.

**Displaying Your Access Level** (7) (9)

From the Programming Menu, **enter** (7) (9). The zone corresponding to your Access Level will show



Press **(RESET)**, the system will then automatically revert to the Programming Menu.

**The Communicator Interface** (8) (0) - (8) (1)

The Control Panel features an eight output channel digital communicator interface with Line Monitor (L/M) and Remote Reset (R/R) inputs. The polarity of the outputs and the R/R input is programmable.

**NOTE** The L/M input should be connected to 0V (AUX-) if not required, otherwise Bell Delay will not operate.

**Programming Communicator Selections** (8) (0)

From the Programming Menu, **enter** (8) (0). The display will show the options currently selected.



Press the appropriate numbered button(s) to select or de-select the corresponding option(s) as shown on the display.

**NOTE** To display an explanation of the Comm. options associated with a particular number, **press and hold the corresponding key** (?) (LCD Keypad only).

Press **(PROG.)**. The system will chime to confirm that the new options have been accepted. The system will then automatically revert to the Programming Menu.

Option	Communicator Selections	Factory Setting
1	Communicator Outputs Latch until System is Reset	On
2	Line Monitor Input causes Tamper Alarm on Line Cut	Off
3	Invert Communicator Outputs (off = active low, on = active high)	Off
4	Invert Remote Reset Input (off = active if negative removed, on = active if negative applied)	Off
5	Remote Reset Input Silences Internal Sounder during Alarm	Off
6	Remote Reset Input Clears Engineer Reset (see page 21)	Off
7	Silent PA	Off
8	Enable 90 Second Abort Time Limit	On

**Option 1 - Communicator Outputs Latch Until Reset**  
When 'ON' ALL of the communicator outputs latch until the system is reset, instead of activating for 2 seconds.

**NOTE** Do not use non-latching communicator outputs if selecting Automatic Omit (see page 22).

**Option 2 - Line Monitor Input Causes Tamper**  
When 'ON' a line fault condition causes a Tamper alarm.

**NOTE** The L/M input should be connected to 0V (AUX-) if not required, otherwise Bell Delay will not operate.

**Option 3 - Invert Communicator Outputs**  
When 'ON' ALL of the communicator outputs are inverted from 0V applied on activation to 0V removed on activation.

**Option 4 - Invert Remote Reset Input**  
When 'ON' the operation of the R/R input is inverted from 0V to reset to 12V to reset.

**Option 5 - Remote Reset Input Silences Sounders**  
When 'ON' the R/R input can be used to silence the internal sounder during an alarm (except a fire alarm) to facilitate Audio Verification (A/V).

**Option 6 - Remote Reset Input Clears Engineer Reset**  
When 'ON' activating the R/R input will clear perform an Engineer Reset (see page 21).

**NOTE** It is valid to select both Options 5 and 6 if required.

**Option 7 - Silent PA**  
When 'ON' PA zones (see page 25) have a silent response (just activation of the PA channel on the communicator interface with no local audible or visible alarm response at all).

**Option 8 - Enable 90 Second Abort Time**  
When 'ON' the system will only send an abort if a valid code is entered within 90 seconds of an alarm activation. When 'OFF' the system will send an abort whenever a valid code is first entered after an alarm activation.

**Testing the Communicator Interface** (8) (1)

From the Programming Menu, enter (8) (1). The zone lights indicating the current status of the eight channels will illuminate.



Press the appropriate numbered button(s) to toggle one or more of the outputs. Press (RESET) to return to the Programming Menu. All the zone lights will illuminate.

**The 250 Event Extended Log** (9) (4)

The Control Panel incorporates a time and date stamped, non-volatile, 250 Event Extended Log which can neither be erased nor altered.

**NOTE** The 250 Event Extended Log can only be accessed using an LCD keypad or a computer running Veritas UDL software.

The date (see page 27) and time (see page 28) must be programmed for the 250 Event Extended Log to function correctly.

**Viewing the Extended Log** (9) (4)

From the Programming Menu, enter (9) (4) followed by (Prog). The display will look like this.

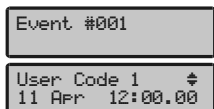

Use the (Up/Down) key to scroll up and down through the other events.

**NOTE** Wherever a ↗ symbol appears on the display, press (Omit) to display more information i.e. zone types etc.

When completed, press (Reset). The system will return to the Programming Menu.

**Event Log Descriptions**

Event	Meaning
Code: ????????	Access code entered for user ????????
Full Set	The alarm system has been full set
Part Set #?	The system has been part set using suite #?
System Unset	The alarm system has been unset
Zones Omitted	Zones have been manually omitted
System Reset	The alarm system has been reset
Code: Anti-Code	The alarm system has been reset using the anti-code
Keypad Entry	Entry mode started using the keypad
Zone ? Open	Zone ? has been activated
Zone ? Shut	Zone ? has been restored
EOL Tamper	There has been an EOL zone tamper
EOL Restore	The EOL zone tamper has been restored
Alarm	There has been an alarm activation
Keypad PA	A keypad PA alarm has been activated
RKP PA Restore	The keypad PA alarm has been restored
Lid Tamper	The panel lid has been removed
Lid Restore	The panel lid tamper has been restored
Bell/Gbl Tamper	The bell/global tamper has been activated
Bell/Gbl Restore	The bell/global tamper has been restored
Code PIN Tamper	Too many invalid key presses has caused a tamper alarm
Code PIN Restore	The code tamper alarm has been restored
RKP Online	A keypad has been recognised by the control panel
RKP Offline	A keypad has stopped communicating with the control panel
Mains LO	The AC mains has failed
Mains OK	The AC mains has been restored
Volts LO	The battery voltage is low
Volts OK	The battery voltage is ok
Line Cut	The phone line has been removed from the communicator
Line Restore	The phone line has been restored
User Programming	User Programming mode was selected
Eng. Programming	Installer Programming mode was selected
Date Changed	The control panel date has been changed
Time Changed	The control panel time has been changed
SSD Change	Site specific data has been changed
Non-SSD Change	Non site specific data has been changed
Defaults Loaded	The factory default values have been loaded
Sys Check = 5	Factory set parameters
Unknown	No event

**Programming Text** 9<sub>prog</sub> 5<sub>pr</sub> - 9<sub>prog</sub> 9<sub>prog</sub>

Text is programmed in a similar way to mobile phones. Characters are selected by pressing the corresponding key the appropriate number of times (to select a character on the same key, press  to move the cursor along) i.e. to spell the word PIR, type 7444777.

The table below shows the keys to use and the characters that are assigned to them:

Key	Text									
1	.	,	1	'	#	&	+	-	/	:
2 <sub>abc</sub>	A	B	C	2						
3 <sub>def</sub>	D	E	F	3						
4 <sub>ghi</sub>	G	H	I	4						
5 <sub>jkl</sub>	J	K	L	5						
6 <sub>mno</sub>	M	N	O	6						
7 <sub>pqrs</sub>	P	Q	R	S	7					
8 <sub>tuv</sub>	T	U	V	8						
9 <sub>wxyz</sub>	W	X	Y	Z	9					
0	┐	0								
Full	Advance Cursor									
Chime	Backspace									
Omit	Upper/Lower Case & Numerical									
Prog	Accept New Text									



 **NOTE** Whenever text is programmed, the 'Broadcast Text' option must be used to send the programmed text, to all keypads connected to the system (see page 36).

**Programming Zone Text** 9<sub>prog</sub> 5<sub>pr</sub>

Up to 10-characters of descriptive text can be programmed for each zone i.e. Front Door, Hall, Bedroom 1, etc.

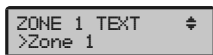
From the Programming Menu, **enter** 9<sub>prog</sub> 5<sub>pr</sub>. The display will look like this.





**Select characters by pressing the corresponding key the appropriate number of times** (to select a character on the same key, press  to move the cursor along). **Press** . The system will chime to confirm that the Text has been accepted. The system will then automatically revert to the Programming Menu.

**Programming User Name Text** 9<sub>prog</sub> 6<sub>pr</sub>

Up to 8-characters of descriptive text can be programmed for each user i.e. John, Mike, Susan, etc.

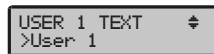
From the Programming Menu, **enter** 9<sub>prog</sub> 6<sub>pr</sub>. The display will look like this.





**Select characters by pressing the corresponding key the appropriate number of times** (to select a character on the same key, press  to move the cursor along). **Press** . The system will chime to confirm that the Text has been accepted. The system will then automatically revert to the Programming Menu.

**Banner Text** 9<sub>prog</sub> 7<sub>pr</sub>

This 16-character message is displayed above the time and date whenever the control panel is set or unset.

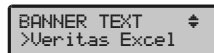
From the Programming Menu, **enter** 9<sub>prog</sub> 7<sub>pr</sub>. The display will look like this.





**Select characters by pressing the corresponding key the appropriate number of times** (to select a character on the same key, press  to move the cursor along). **Press** . The system will chime to confirm that the Text has been accepted. The system will then automatically revert to the Programming Menu.

**Broadcast Text** 9<sub>prog</sub> 8<sub>pr</sub>

This option sends any programmed text, to all keypads connected to the system (must be done whenever new text is programmed).

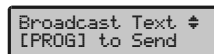
From the Programming Menu, **enter** 9<sub>prog</sub> 8<sub>pr</sub>. The display will look like this.





**Press** . The system will chime to confirm that the text has been broadcast to the other keypads. The system will then automatically revert to the Programming Menu.

**Default Text** 9<sub>prog</sub> 9<sub>pr</sub>

This option will default all of the programmable text values.

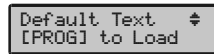
From the Programming Menu, **enter** 9<sub>prog</sub> 9<sub>pr</sub>. The display will look like this.



**Press** . The system will chime to confirm that the text has been defaulted. The system will then automatically revert to the Programming Menu.

# 5. Specifications

## Control Panel

### Power supply

<b>Mains Supply Voltage:</b>	230VAC (±10%) 115VAC (±10%)
<b>Maximum Total Current Rating</b>	1ADC
230VAC/115VAC (±5%)	<5%
<b>Ripple</b>	<5%
<b>Rechargeable Battery Type</b>	12V Sealed Lead Gel Acid

### Electrical

<b>Current Consumption</b>	
Quiescent	<50mA
In Alarm	<150mA
<b>Fuses</b>	
FTB Mains 230V	125mA, 250V, 20mm
FTB Mains 115V	250mA, 250V, 20mm
F1 - Battery	1 Amp, 250V, PTC
F2 - Bell	1 Amp, 250V, PTC
F3 - Auxiliary	500mA, 250V, PTC
F4 - Network	500mA, 250V, PTC
F5 - Power Supply Output	1.6 Amp, 250V, PTC
<b>Rechargeable Battery Capacity</b>	12V 1.2Ah to 7Ah
<b>Number Of Zones</b>	8
<b>Zones Types</b>	N/C, N/O or EOL
<b>Network</b>	
+	+12V Power
-	0V Power
T	Transmitted Data
R	Received Data
<b>Types Of Remote Keypads</b>	LED or 32 Character LCD
<b>Number Of Remote Keypads</b>	Up to six (mixed)
<b>Communicator Outputs 1 to 8</b>	100mA switched to 0V
<b>Internal Speaker</b>	
Minimum Load	16Ω
Low Volume	Adjustable
High Volume	>90dB at 1m

### Physical

<b>Dimensions</b>	282mm x 225mm x 80mm
<b>Battery Compartment</b>	Up to one 12V 7Ah battery

### Environmental

<b>Operating Temperature</b>	-10°C (+14°F) to +50°C (+122°F)
<b>Storage Temperature</b>	-20°C (-4°F) to +60°C (+140°F)
<b>Maximum Humidity</b>	95% non-condensing
<b>EMC Environment</b>	Residential, Commercial, Light Industrial & Industrial

### Keypads

### Electrical

<b>Operating Voltage</b>	10V - 13.7VDC
<b>Current Consumption</b>	<85mA
<b>Volume</b>	Dual Level
<b>Cable</b>	4-Core, ≤100m, Star, Daisy Chain or any combination

### Safety Notes

-  Mains voltage is factory set and not adjustable - see label on transformer.
- Removal of the transformer is prohibited and will invalidate the warranty.
- Only use batteries of the specified type.
- Dispose of used batteries safely according to the manufacturer's instructions.
- Locate the battery inside the panel in the space provided.
- This equipment is designed for dry indoor use only.
- When replacing a fuse always observe the specified rating and type - failure to do so is dangerous and will invalidate the warranty. Fuses should comply with IEC 127.
- The press-seal bag must NOT be stored inside the panel.

### Warranty

All Texecom products are designed for reliable, trouble-free operation. Quality is carefully monitored by extensive computerised testing. As a result the Control Panel is covered by a two year warranty against defects in material or workmanship (details on request).

As the Control Panel is not a complete alarm system but only a part thereof, Texecom cannot accept responsibility or liability for any damages whatsoever based on a claim that the Control Panel failed to function correctly. Due to our policy of continuous improvement Texecom reserve the right to change specification without prior notice.

The Veritas R8Plus/Veritas Excel, Veritas R8 Keypad, and Veritas Excel Keypad are protected by UK & International Registered Design. Registered Design Numbers: 2041830, 2047440 and 2089016

veritas is a trademark of Texecom Ltd.

## European Standards

Conforms to European Union (EU) Low Voltage Directive (LVD) 73/23/EEC (amended by 93/68/EEC) and Electro-Magnetic Compatibility (EMC) Directive 89/336/EEC (amended by 92/31/EEC and 93/68/EEC).

The CE mark indicates that this product complies with the European requirements for safety, health, environmental and customer protection.

### EN 50131

In order to comply with EN 50131-1 several functional changes may be invoked using Miscellaneous Selections Zero, Option 5 (see page 20). In addition the following points should be noted:

- In order to comply with EN 50131-1 Engineer access must first be authorised by a user, therefore Installer codes will only be accepted when the system is unset. If additional restriction is required then Engineer access may be time limited to the first 30 seconds after the system is unset (see page 20).
- In order to comply with EN 50131-1 neither Internals Only nor Part Set Zone Alarm nor Internals Only on Part Set Tamper Alarm should be selected (see page 20).
- In order to comply with EN 50131-1 Single Button Setting should not be selected (see page 20).
- In order to comply with EN 50131-1:
- Do not fit more than 10 unpowered detectors per zone,
- Do not fit more than one non-latching powered detector per zone,
- Do not mix unpowered detectors and non-latching powered detectors on a zone.
- In order to comply with EN 50131-1 the Entry Time should not be programmed to more than 45 seconds (see page 29).
- In order to comply with EN 50131-1 the Bell Cut-Off Time should be programmed between 02 and 15 minutes (see page 29).
- In order to comply with EN 50131-1 the Bell Delay Time should not be programmed to more than 10 minutes (see page 29).
- EN 50131-1 requires that detector activation LEDs shall only be enabled during Walk Test. This is most conveniently achieved by using detectors with a Remote LED Disable input connected to the panel SW+ output, programmed to operate during Walk Test (see page 24).
- EN 50131-6 requires that the power supply output ripple should not exceed 5% at mains voltages down to 207VAC. This limits the maximum rated output of the power supply to 600mA. The power supply can supply more than this at higher mains voltages or if greater ripple is accepted, for example at 230VAC the power supply can deliver up to 1A.
- The standby time is the time for which the system power supply is capable of supplying its rated output current when running on battery only (i.e. in the event of mains failure). In order to comply with EN 50131-1 the standby time should be at least 8 hours for Grade 1 Systems and at least 15 hours for Grade 2 Systems. In order to comply with EN 50131-6 the Standby Time should be at least 12 hours for both Grade 1 and 2 Systems. For smaller battery sizes this means that the rated output of the power supply will actually be determined by the capacity of the standby battery and will be less than the power supply is capable of supplying (with the mains on). The rated output of the power supply may be calculated by dividing the capacity of the battery by the required standby time where the result is smaller than the maximum rated output of 600mA.

Rated output currents for typical battery sizes are shown in the following table:

Battery Capacity	Standby Time			
	1.2Ah	8hrs	12hrs	15hrs
2.1Ah	150mA	100mA	80mA	80mA
3.0Ah	263mA	175mA	140mA	140mA
7.0Ah	375mA	250mA	200mA	200mA
	600mA	583mA	467mA	467mA

1. Engineer Reset prevents the user from resetting the system. It is not in itself a method of resetting the system.
2. EN 50131-1 separately defines Zone Inhibit and Zone Isolate optional facilities. The Zone Omit facility supported by the Control Panel corresponds to Inhibit. The Zone Disable facility supported by the Control Panel corresponds to Isolate.
3. When the battery voltage falls below the minimum system operating voltage it will be indicated as a power fault if the mains is on and will cause alarm if the mains is off.
4. The Control Panel Reset facility corresponds to the EN 50131-1 Restore function.
5. EN 50131-6 states that for integrated power supplies the environmental and tamper considerations of the control panel should be applied.

This equipment is designed to enable an intruder alarm system in which it is installed to comply with the requirements of security grades 1 or 2 of EN 50131-1, and EN 50131-6, and is suitable for installation in any indoor environment.



## Access Code Table

User Number	User Name	Default Code PIN	Option to Change PIN	New Code PIN	Default Access Level	Option to Change Level	New Access Level
1		④③②①	⑥①		⑤ Master	⑦①	
2		①②③④	⑥②		⑧ Boss	⑦②	
3		N/A	⑥③		⑦ Null	⑦③	
4		N/A	⑥④		⑦ Null	⑦④	
5		N/A	⑥⑤		⑦ Null	⑦⑤	
6		N/A	⑥⑥		⑦ Null	⑦⑥	
7		N/A	⑥⑦		⑦ Null	⑦⑦	
8		N/A	⑥⑧		⑦ Null	⑦⑧	



NOTE

Customer codes can only be programmed when the Programming Menu is accessed using a Master User code.

Installer codes can only be programmed when the Programming Menu is accessed using a Boss Engineer code.

Access Level	Access Level Number	Access Type	Can be Programmed by
User	①	Customer	Master ④③②①
Engineer	②	Installer	Boss ①②③④
PA (Panic)	③	Customer	Master ④③②①
Duress	④	Customer	Master ④③②①
Master User	⑤	Customer	Master ④③②①
Cleaner	⑥	Customer	Master ④③②①
Null	⑦	Customer	Master ④③②①
		Installer	Boss ①②③④
Boss Engineer	⑧	Installer	Boss ①②③④

# Texecom

Texecom Limited, Bradwood Court, St. Crispin Way, Haslingden, Lancashire BB4 4PW,  
England.

## Technical Support:

UK Customers Tel: 08456 300 600

(Calls charged at local rate from a BT landline. Calls from other networks may vary.)

International Customers Tel: +44 1706 233875

Email: [techsupport@texe.com](mailto:techsupport@texe.com)

© Texecom Limited 2015

INS045-13

